

# ONE RIVER POINT

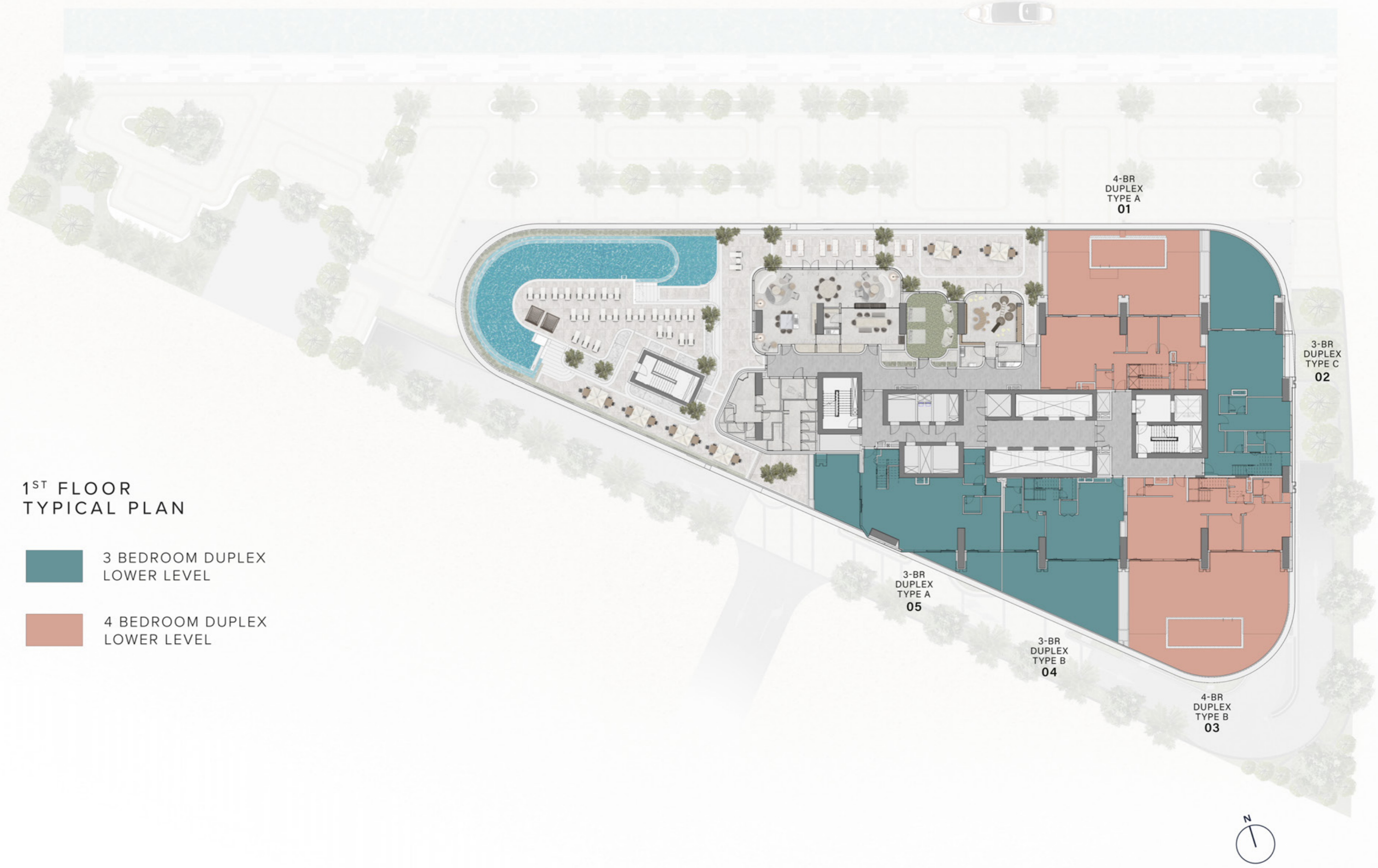

## 1<sup>ST</sup> FLOOR TYPICAL PLAN

-  3 BEDROOM DUPLEX  
LOWER LEVEL
-  4 BEDROOM DUPLEX  
LOWER LEVEL

# ONE RIVER POINT

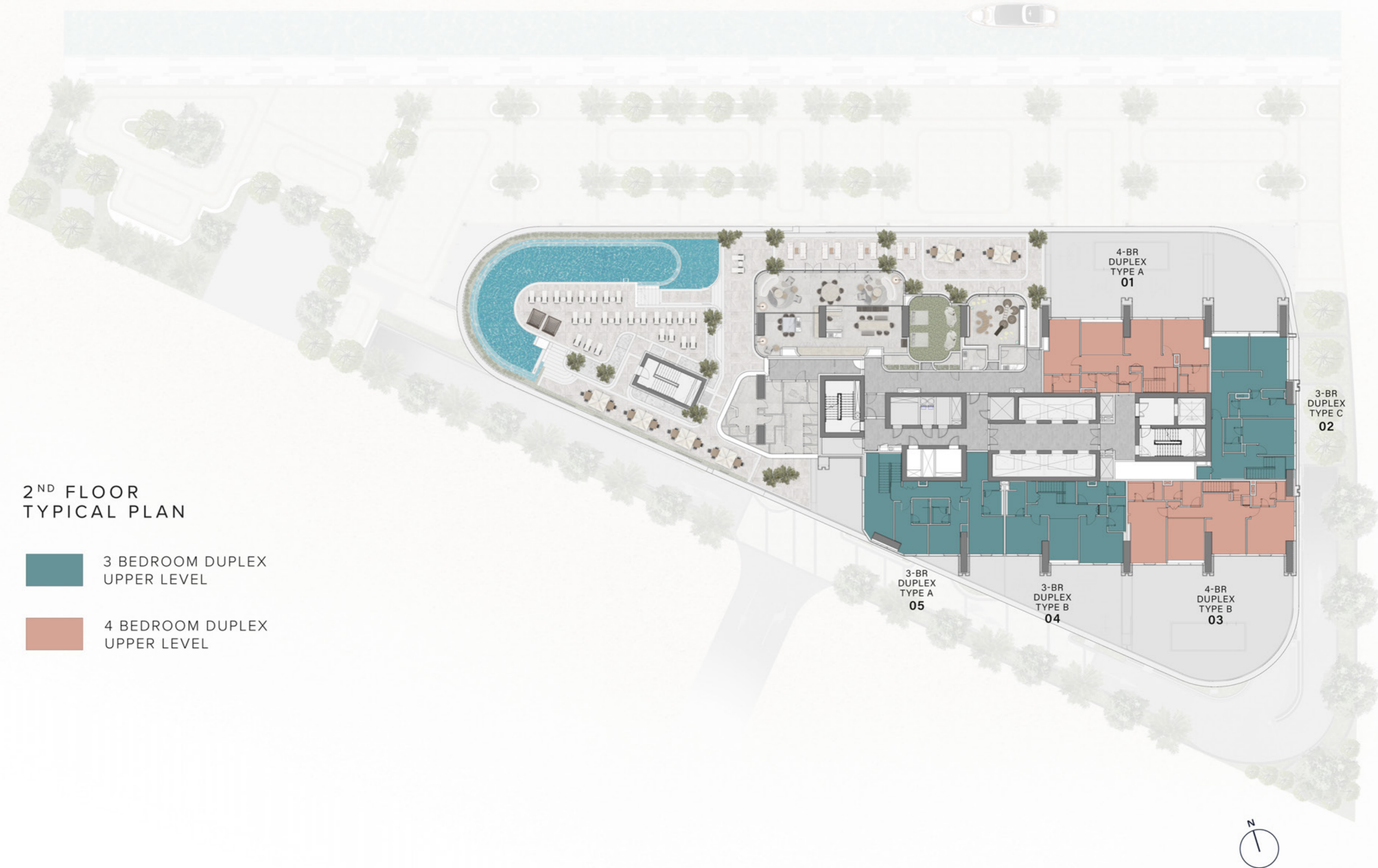

## 2<sup>ND</sup> FLOOR TYPICAL PLAN

-  3 BEDROOM DUPLEX  
UPPER LEVEL
-  4 BEDROOM DUPLEX  
UPPER LEVEL

# ONE RIVER POINT



# ONE RIVER POINT

## 4<sup>TH</sup> FLOOR TYPICAL PLAN

-  1 BEDROOM
-  2 BEDROOM

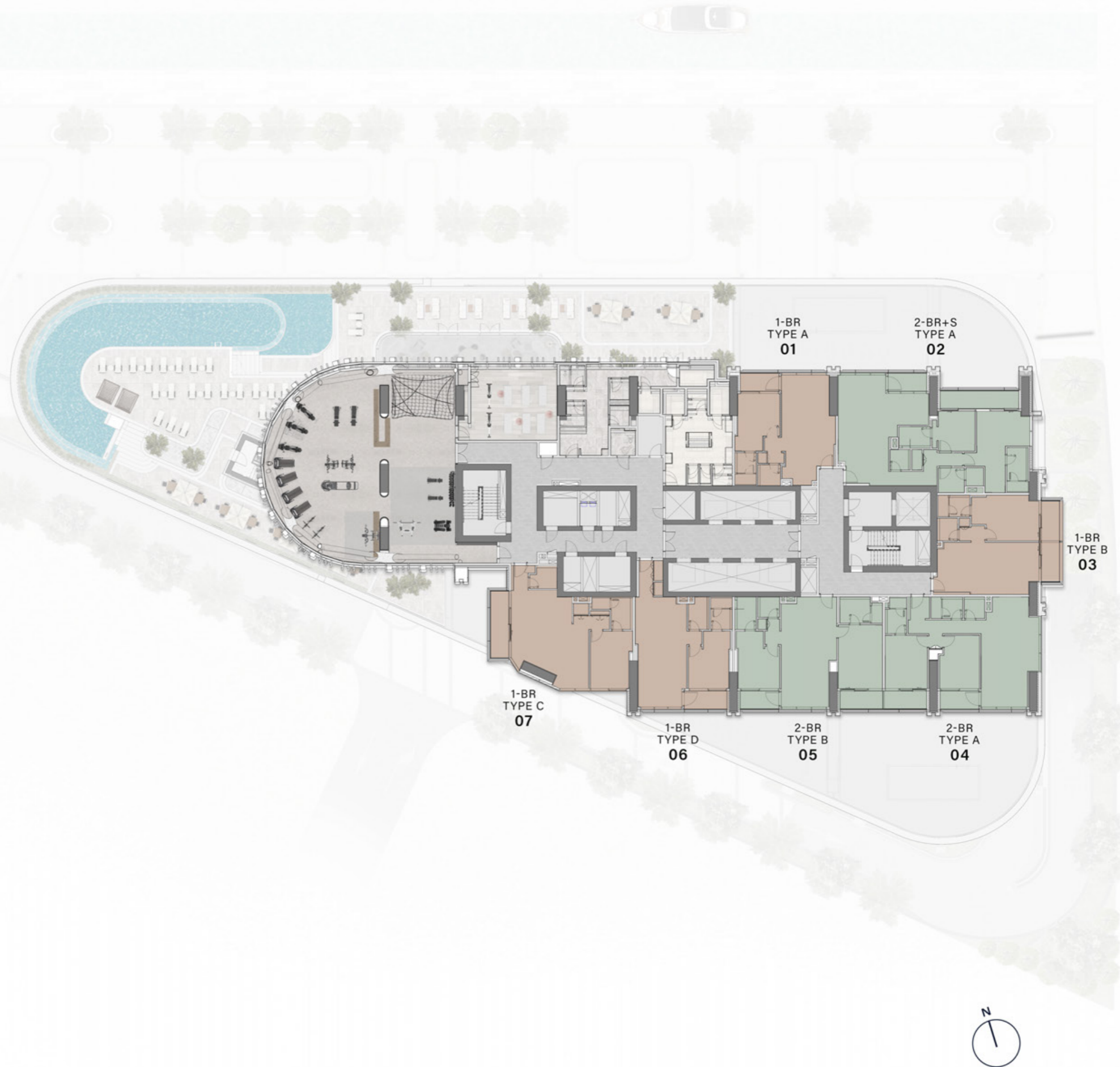

# ONE RIVER POINT

## 5<sup>TH</sup> FLOOR TYPICAL PLAN

-  1 BEDROOM
-  2 BEDROOM

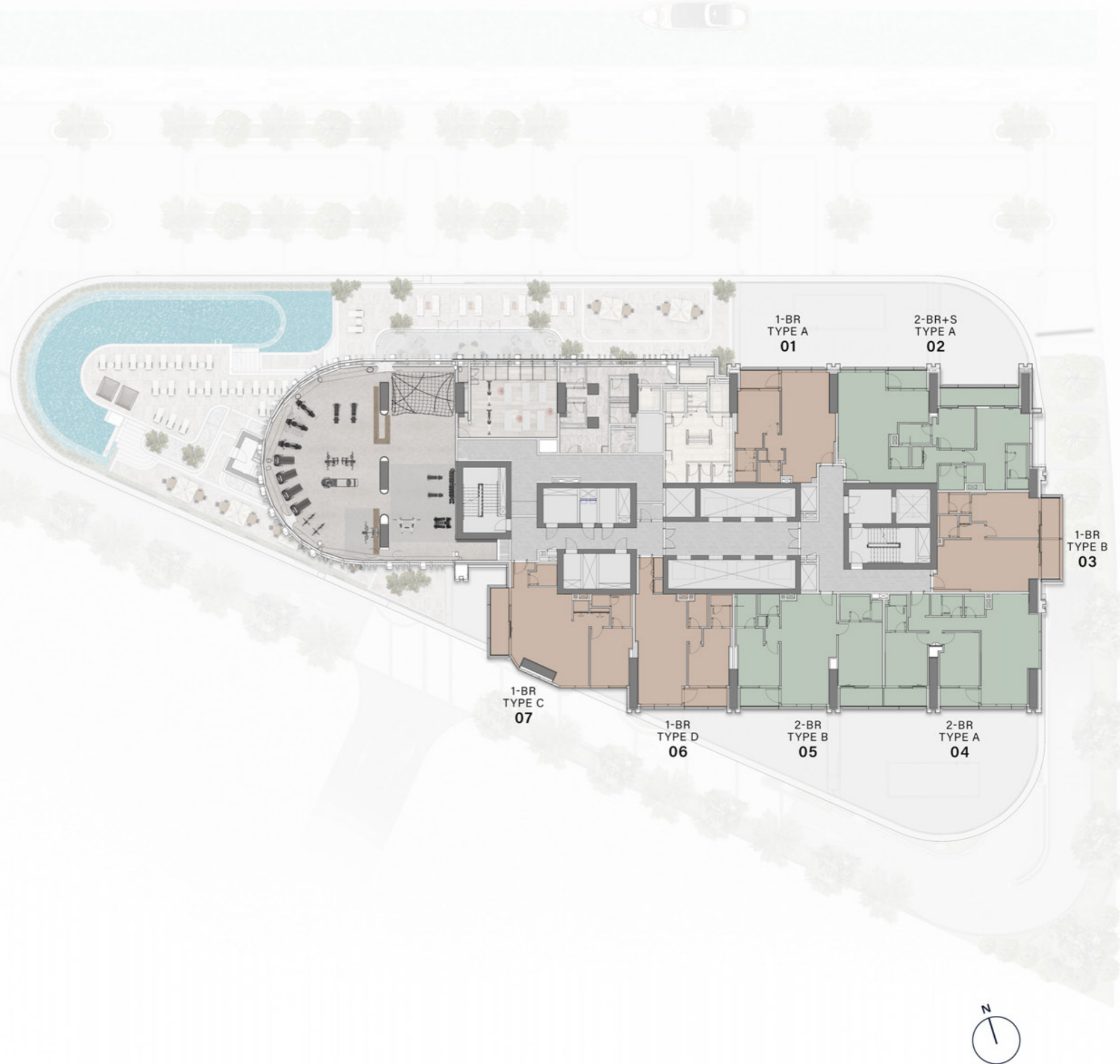

# ONE RIVER POINT

## 6<sup>TH</sup> FLOOR TYPICAL PLAN

-  1 BEDROOM
-  2 BEDROOM



# ONE RIVER POINT

## 7<sup>TH</sup> FLOOR TYPICAL PLAN

-  1 BEDROOM
-  2 BEDROOM



# ONE RIVER POINT

## 8<sup>TH</sup> - 16<sup>TH</sup> FLOOR TYPICAL PLAN

-  1 BEDROOM
-  2 BEDROOM
-  3 BEDROOM

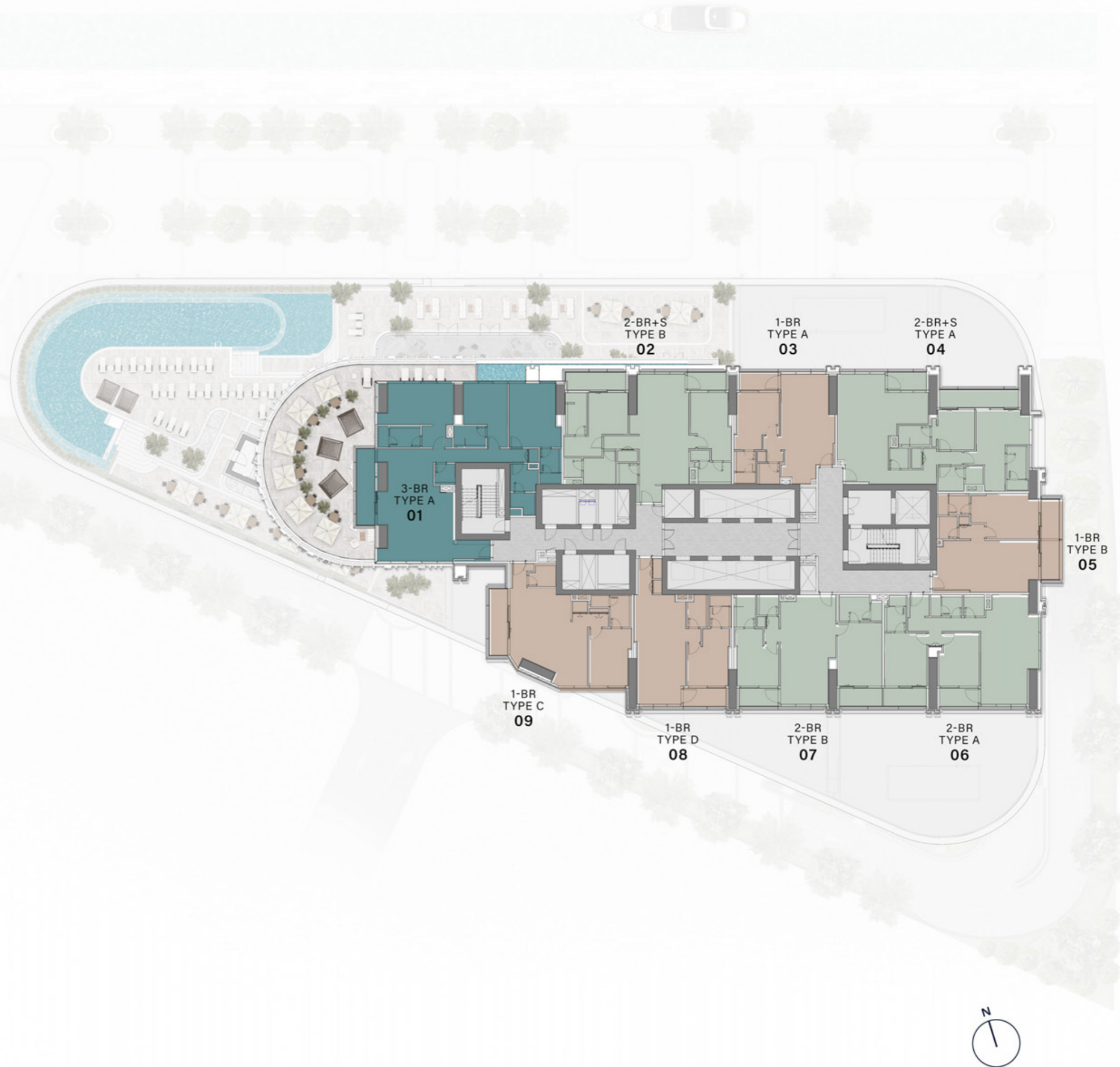

# ONE RIVERPOINT

## 18<sup>TH</sup> - 36<sup>TH</sup> FLOOR TYPICAL PLAN

-  STUDIO
-  1 BEDROOM
-  2 BEDROOM
-  3 BEDROOM

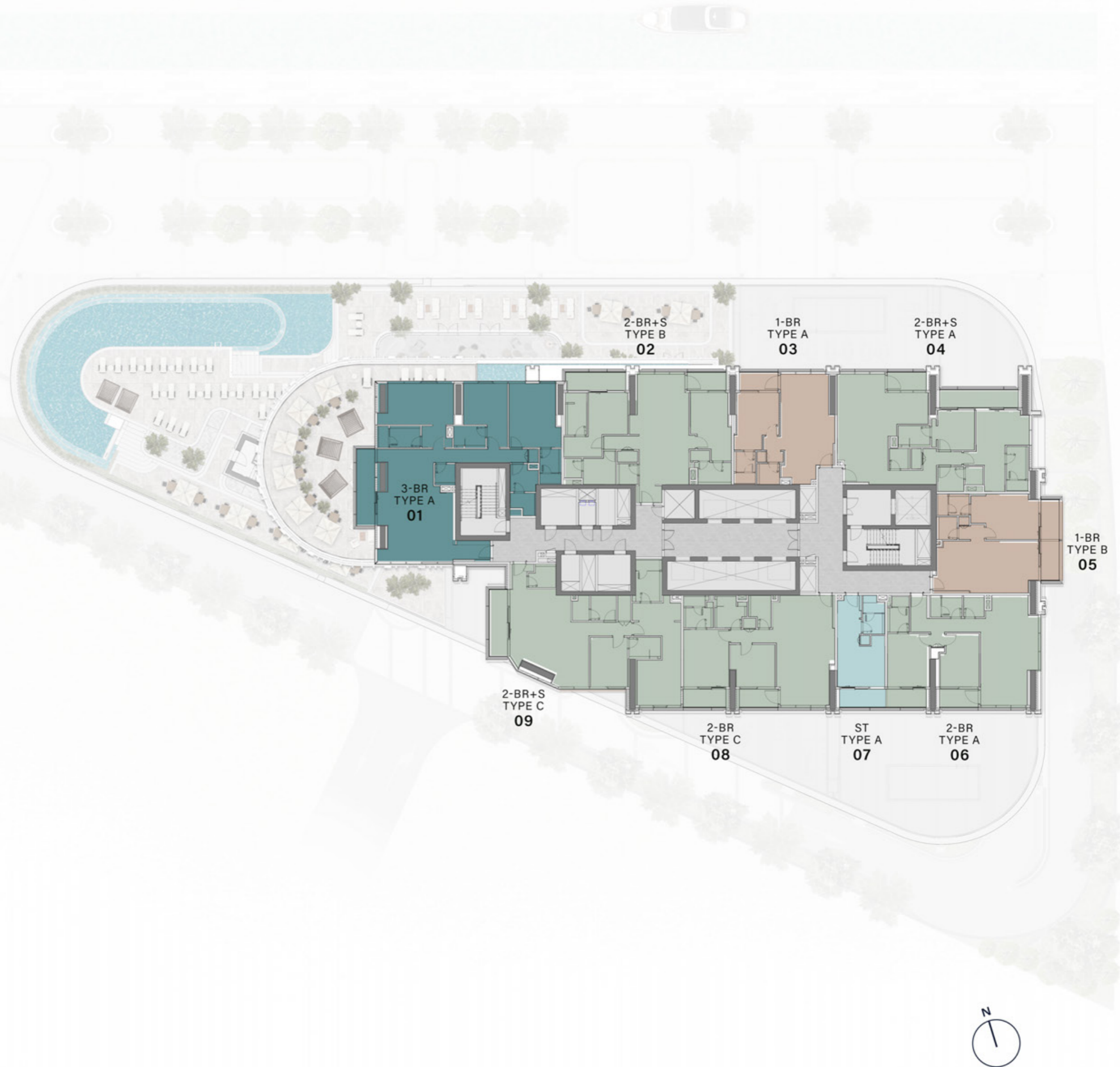

# ONE RIVER POINT

## 37<sup>TH</sup> FLOOR TYPICAL PLAN

-  3 BEDROOM  
PENTHOUSE
-  4 BEDROOM  
PENTHOUSE

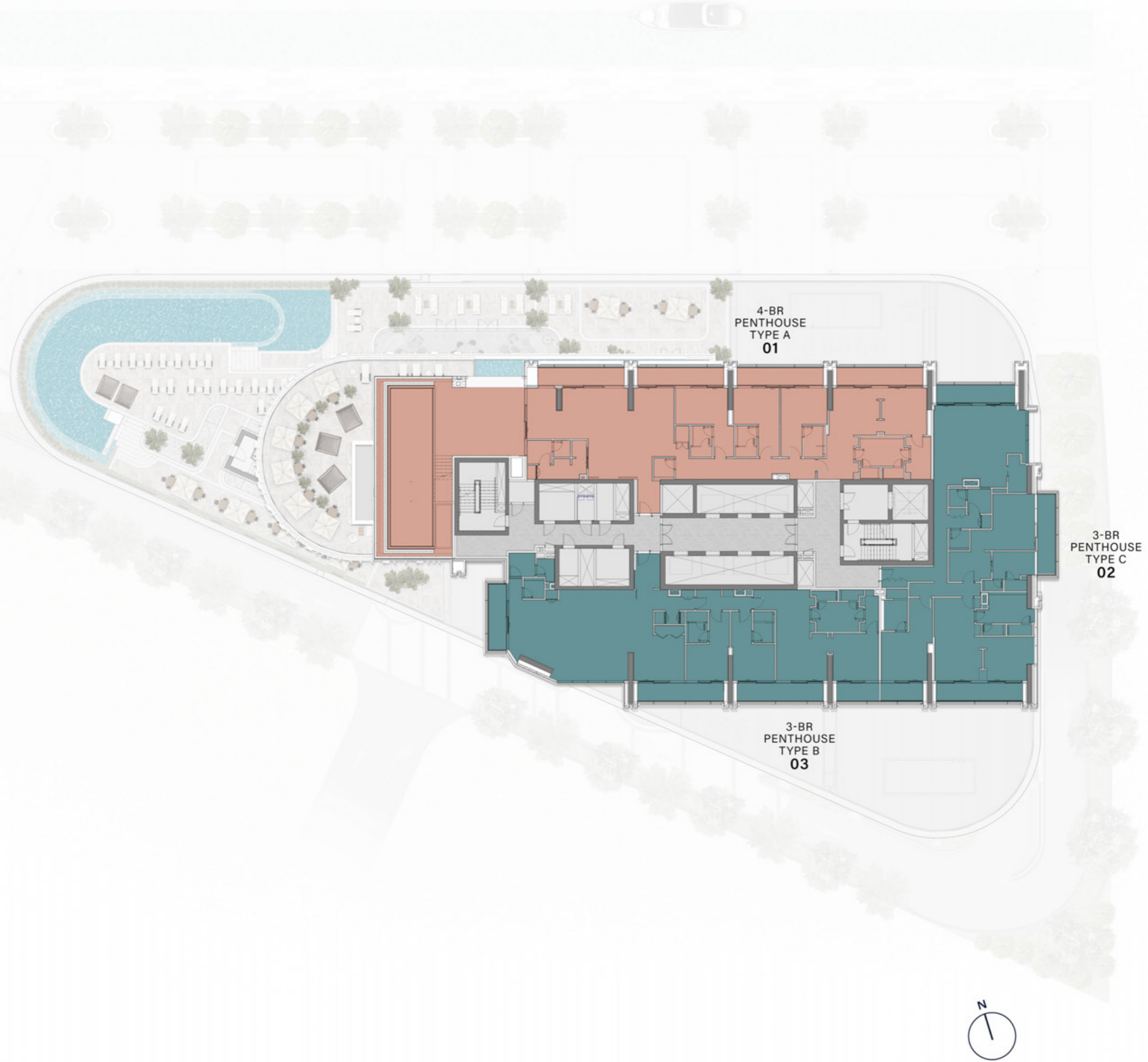

# STUDIO

TYPE A

Internal Living Area : **401.06 Sq. Ft**

Outdoor Living Area : **86.43 Sq. Ft**

Total Living Area : **487.50 Sq. Ft**

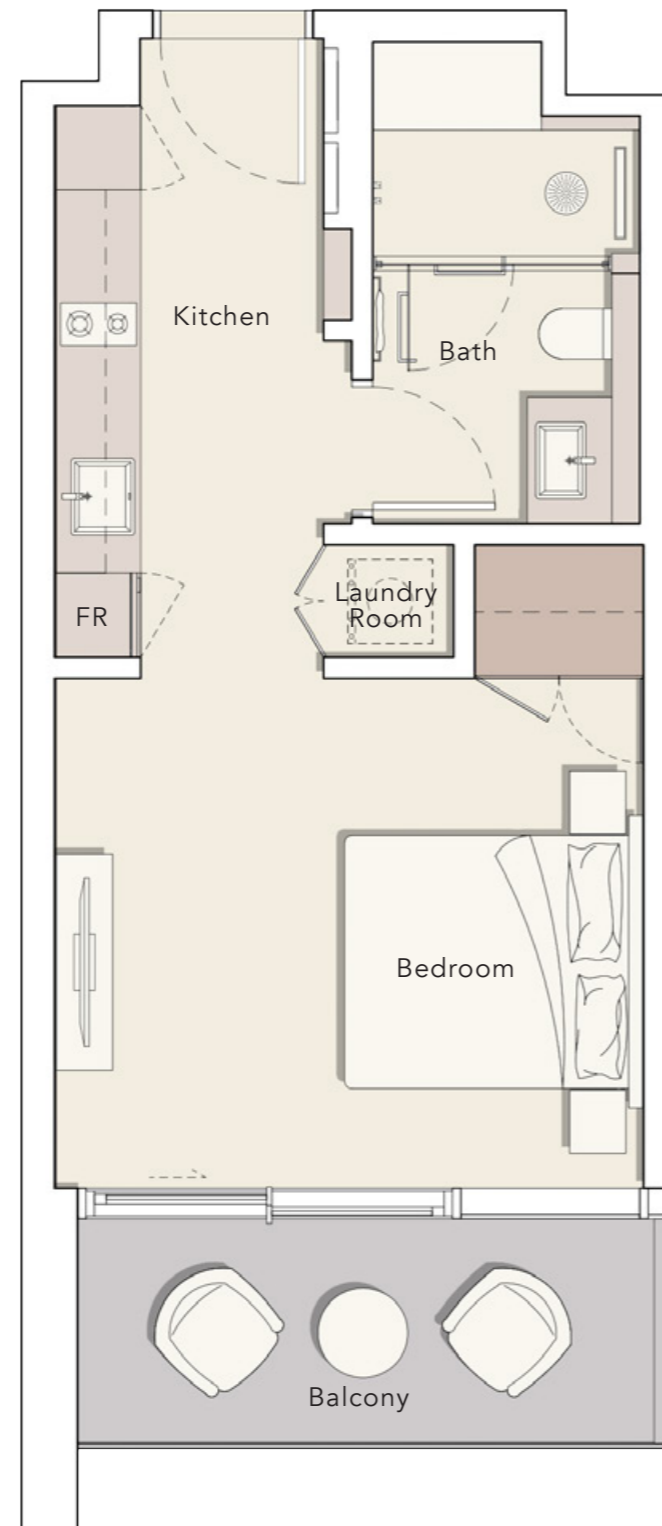

18<sup>th</sup> - 36<sup>th</sup> FLOOR

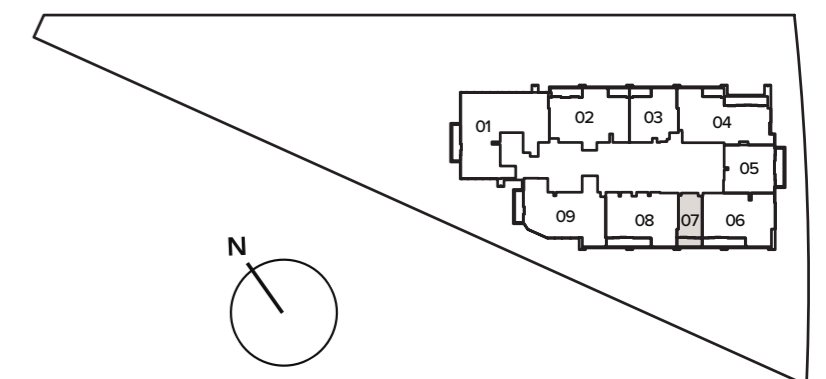

# 1 BEDROOM

TYPE A

Internal Living Area : 886.41 Sq. Ft

Outdoor Living Area : 71.69 Sq. Ft

Total Living Area : 958.10 Sq. Ft



**3<sup>rd</sup> FLOOR**

301

**7<sup>th</sup> FLOOR**

701

**4<sup>th</sup> FLOOR**

401

**8<sup>th</sup> - 16<sup>th</sup> FLOOR**

803

**5<sup>th</sup> FLOOR**

501

**18<sup>th</sup> - 36<sup>th</sup> FLOOR**

1803

**6<sup>th</sup> FLOOR**

601

**8<sup>th</sup> - 16<sup>th</sup> FLOOR**

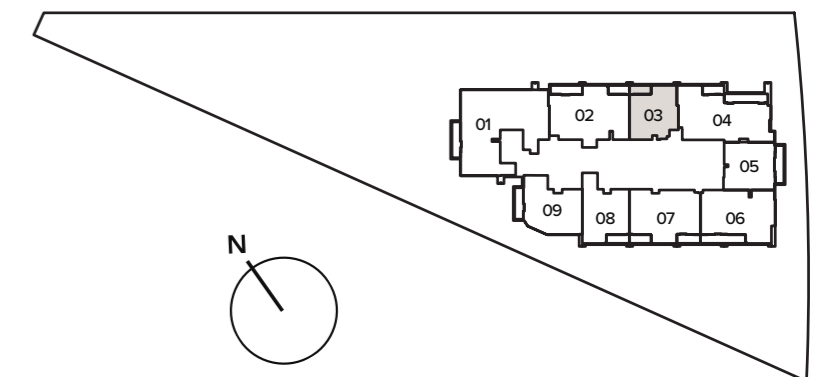

# 1 BEDROOM

TYPE B

Internal Living Area : 930.43 Sq. Ft  
Outdoor Living Area : 129.81 Sq. Ft  
Total Living Area : 1060.25 Sq. Ft

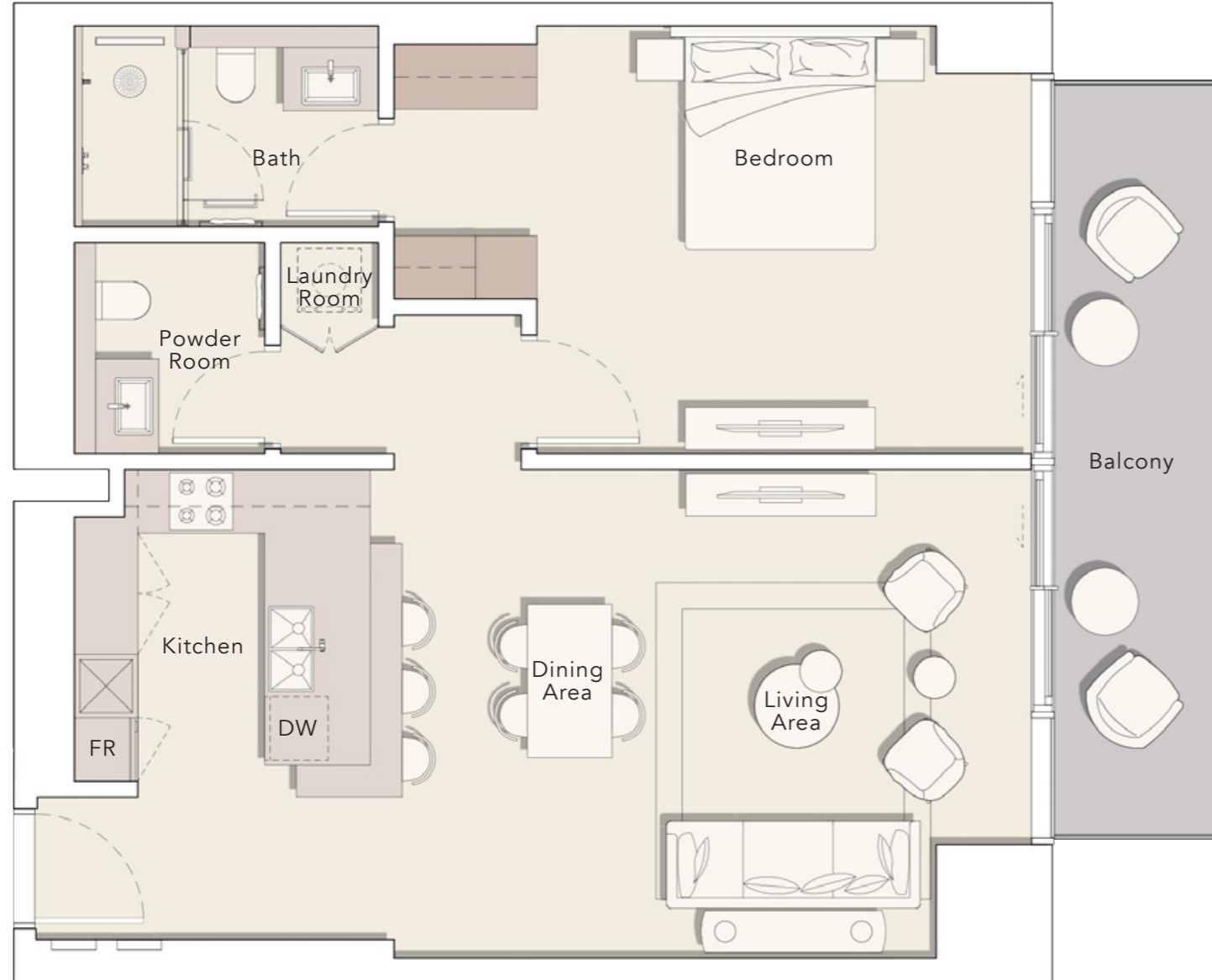

**3<sup>rd</sup> FLOOR**  
303

**7<sup>th</sup> FLOOR**  
703

**4<sup>th</sup> FLOOR**  
403

**8<sup>th</sup> - 16<sup>th</sup> FLOOR**  
805

**5<sup>th</sup> FLOOR**  
503

**18<sup>th</sup> - 36<sup>th</sup> FLOOR**  
1805

**6<sup>th</sup> FLOOR**  
603

**8<sup>th</sup> - 16<sup>th</sup> FLOOR**

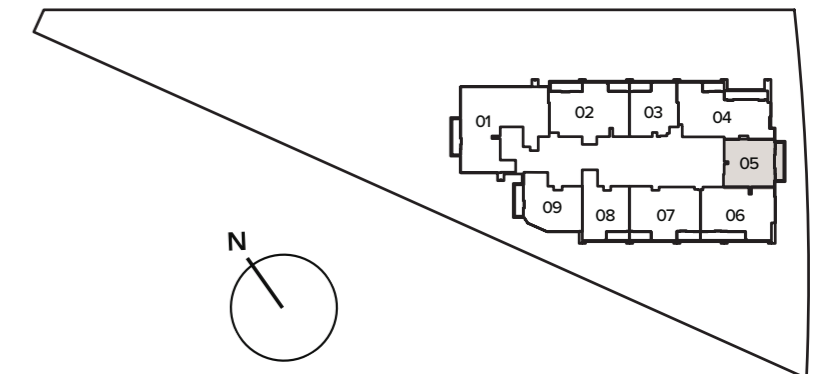

# 1 BEDROOM

TYPE C

Internal Living Area : 1090.49 Sq. Ft

Outdoor Living Area : 107.10 Sq. Ft

Total Living Area : 1197.59 Sq. Ft



**3<sup>rd</sup> FLOOR**

307

**7<sup>th</sup> FLOOR**

707

**4<sup>th</sup> FLOOR**

407

**8<sup>th</sup> - 16<sup>th</sup> FLOOR**

809

**5<sup>th</sup> FLOOR**

507

**6<sup>th</sup> FLOOR**

607

**8<sup>th</sup> - 16<sup>th</sup> FLOOR**

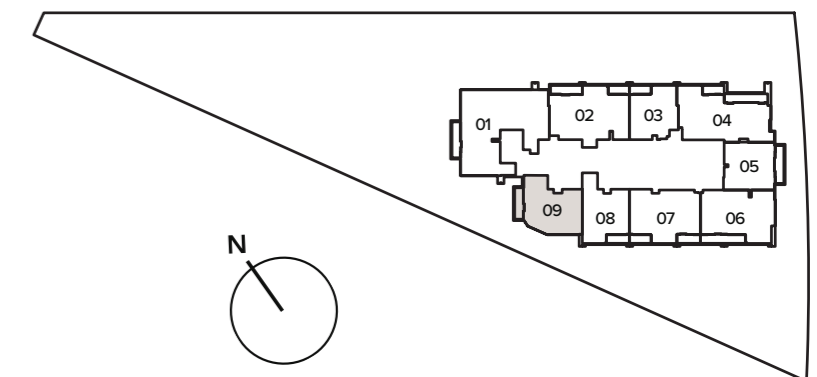

# 1 BEDROOM

TYPE D

Internal Living Area : 991.03 Sq. Ft

Outdoor Living Area : 77.82 Sq. Ft

Total Living Area : 1068.86 Sq. Ft

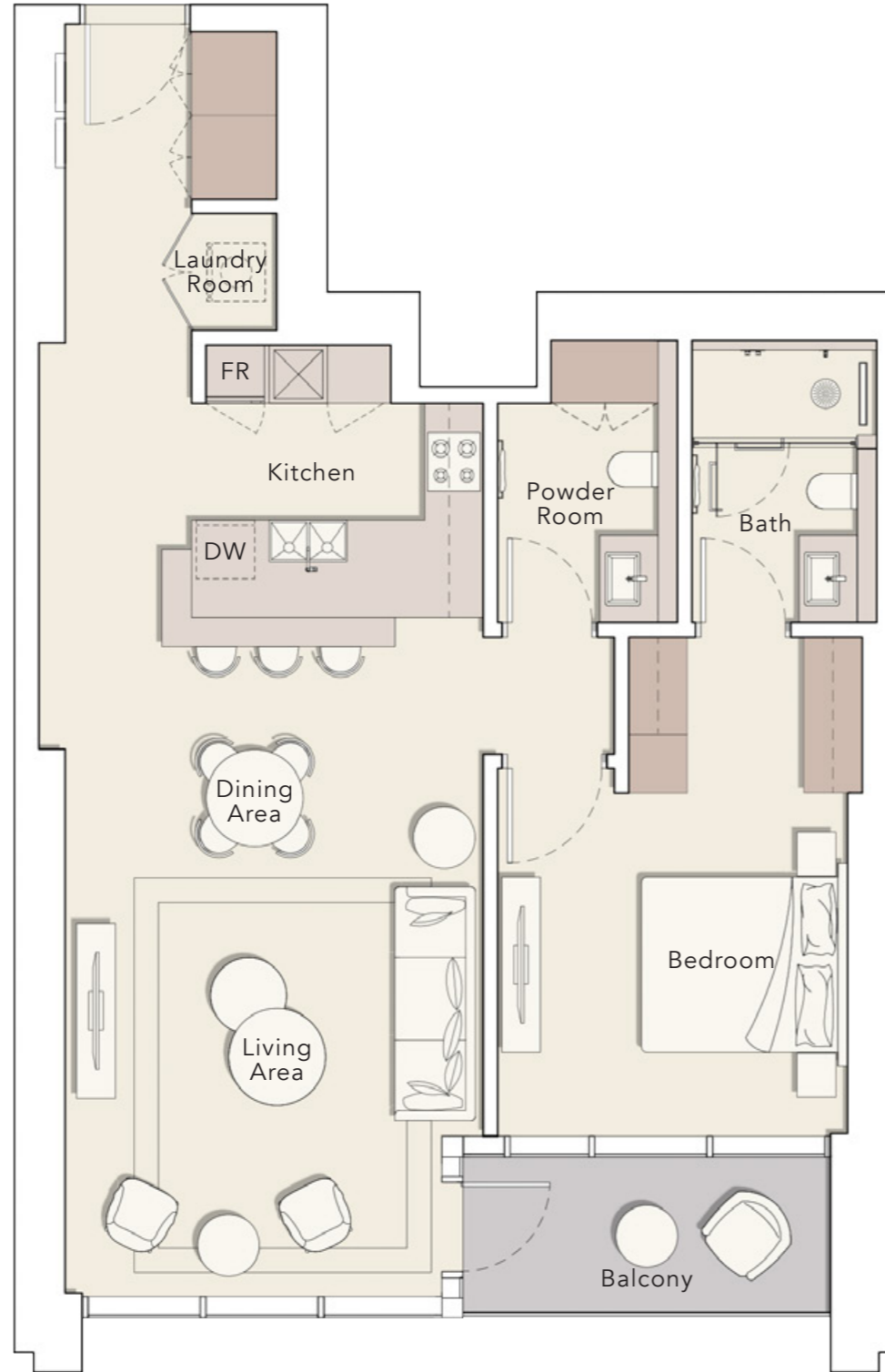

**3<sup>rd</sup> FLOOR**

306

**7<sup>th</sup> FLOOR**

706

**4<sup>th</sup> FLOOR**

406

**8<sup>th</sup> - 16<sup>th</sup> FLOOR**

808

**5<sup>th</sup> FLOOR**

506

**6<sup>th</sup> FLOOR**

606

**8<sup>th</sup> - 16<sup>th</sup> FLOOR**

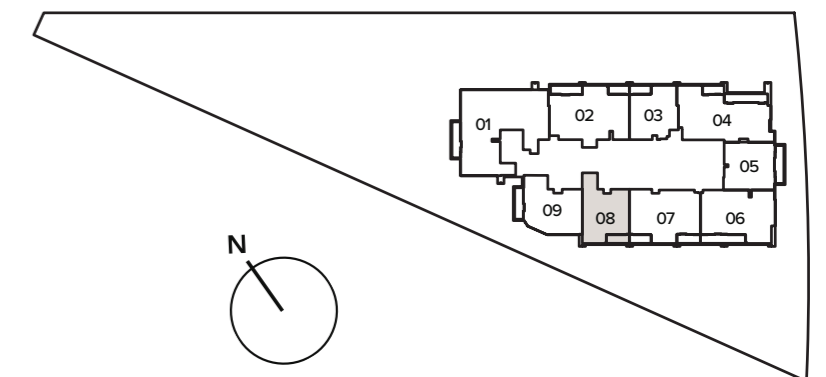

# 2 BEDROOM

TYPE A

Internal Living Area : 1337.31 Sq. Ft

Outdoor Living Area : 152.63 Sq. Ft

Total Living Area : 1489.94 Sq. Ft

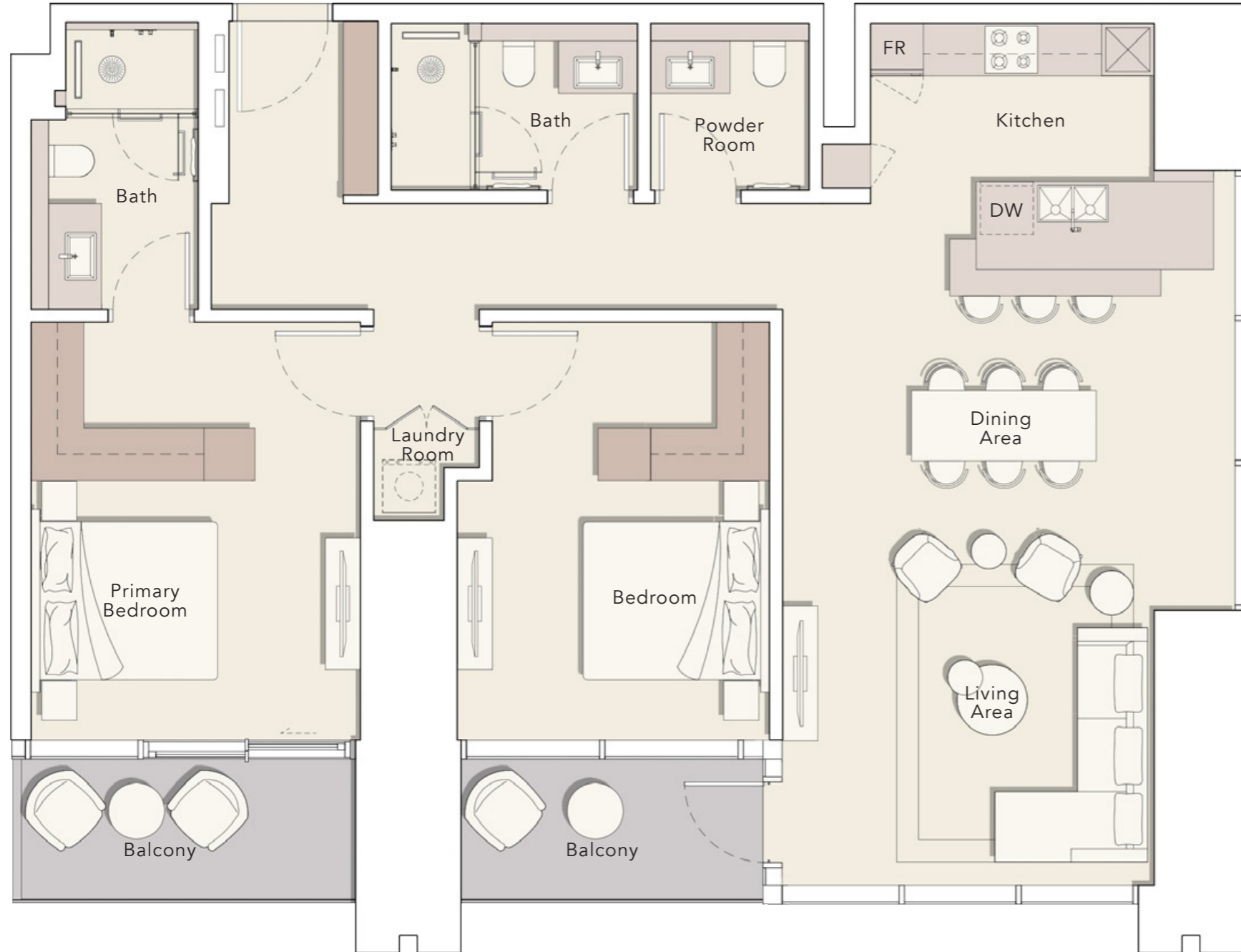

**3<sup>rd</sup> FLOOR**

304

**7<sup>th</sup> FLOOR**

704

**4<sup>th</sup> FLOOR**

404

**8<sup>th</sup> - 16<sup>th</sup> FLOOR**

806

**5<sup>th</sup> FLOOR**

504

**18<sup>th</sup> - 36<sup>th</sup> FLOOR**

1806

**6<sup>th</sup> FLOOR**

604

**8<sup>th</sup> - 16<sup>th</sup> FLOOR**

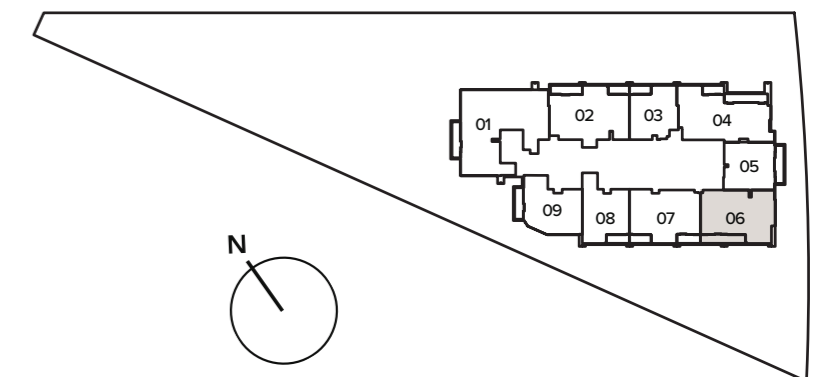

# 2 BEDROOM

TYPE B

Internal Living Area : 1295.22 Sq. Ft

Outdoor Living Area : 152.63 Sq. Ft

Total Living Area : 1447.85 Sq. Ft

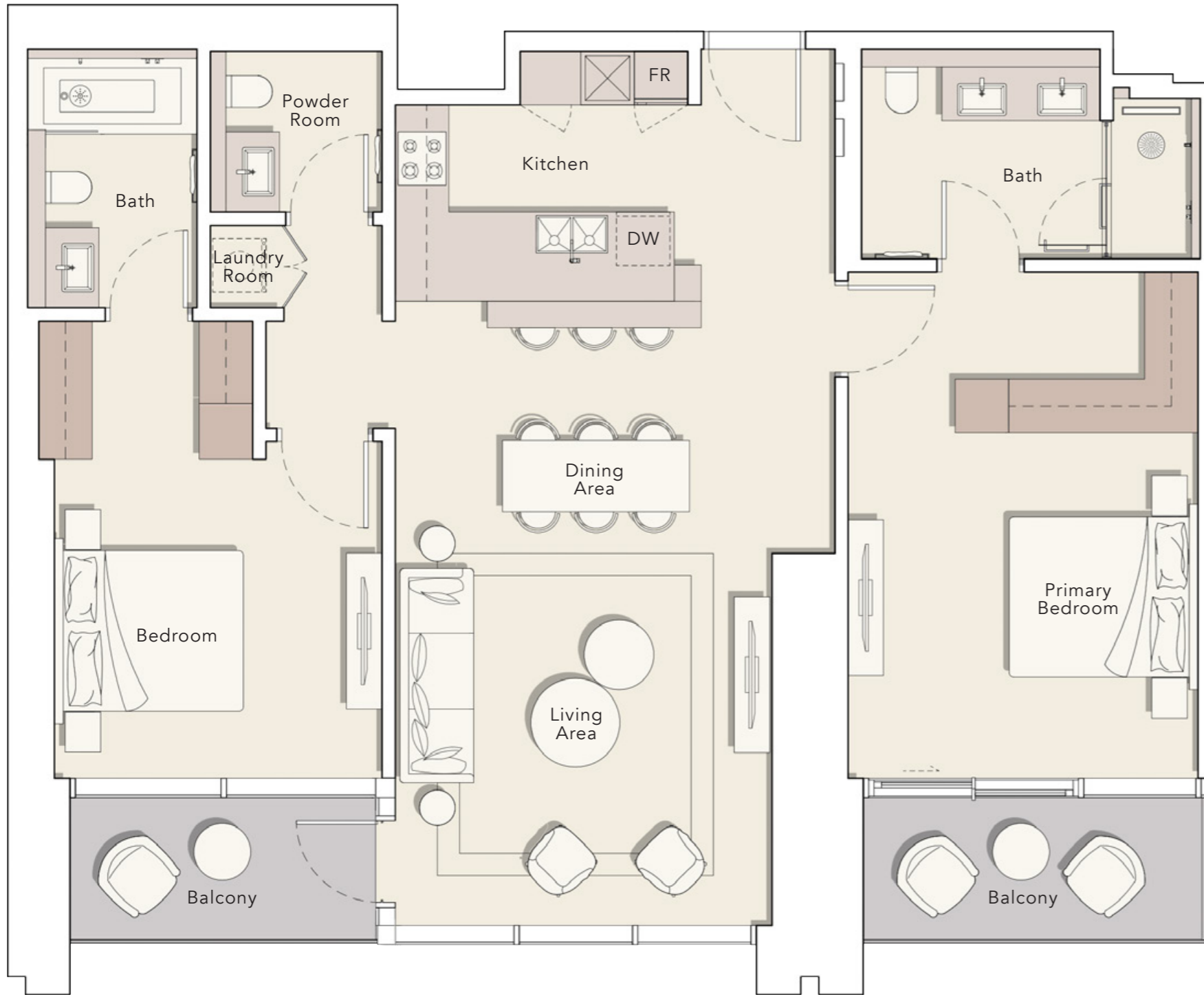

**3<sup>rd</sup> FLOOR**

305

**7<sup>th</sup> FLOOR**

705

**4<sup>th</sup> FLOOR**

405

**8<sup>th</sup> - 16<sup>th</sup> FLOOR**

807

**5<sup>th</sup> FLOOR**

505

**6<sup>th</sup> FLOOR**

605

**8<sup>th</sup> - 16<sup>th</sup> FLOOR**

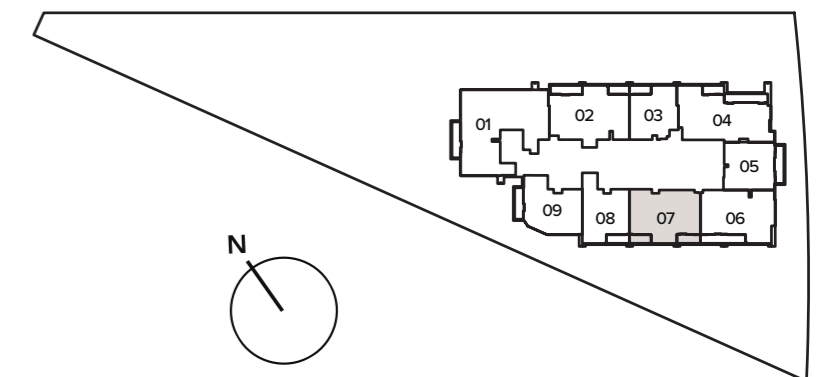

# 2 BEDROOM

TYPE C

Internal Living Area : 1328.48 Sq. Ft

Outdoor Living Area : 151.77 Sq. Ft

Total Living Area : 1480.25 Sq. Ft



18<sup>th</sup> - 36<sup>th</sup> FLOOR

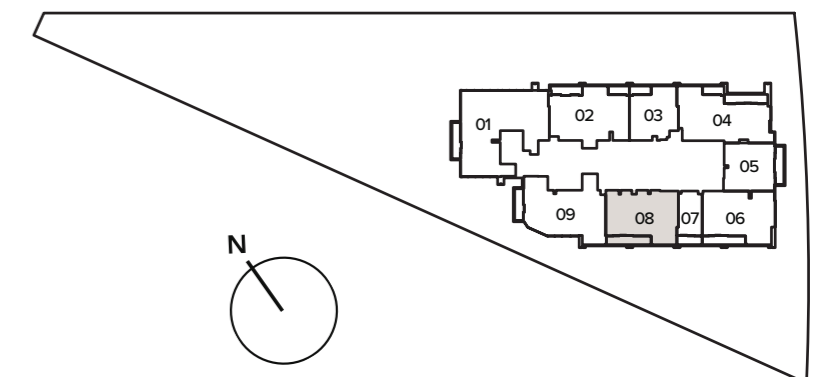

# 2 BEDROOM + S

TYPE A

Internal Living Area : 1573.04 Sq. Ft

Outdoor Living Area : 222.92 Sq. Ft

Total Living Area : 1795.96 Sq. Ft

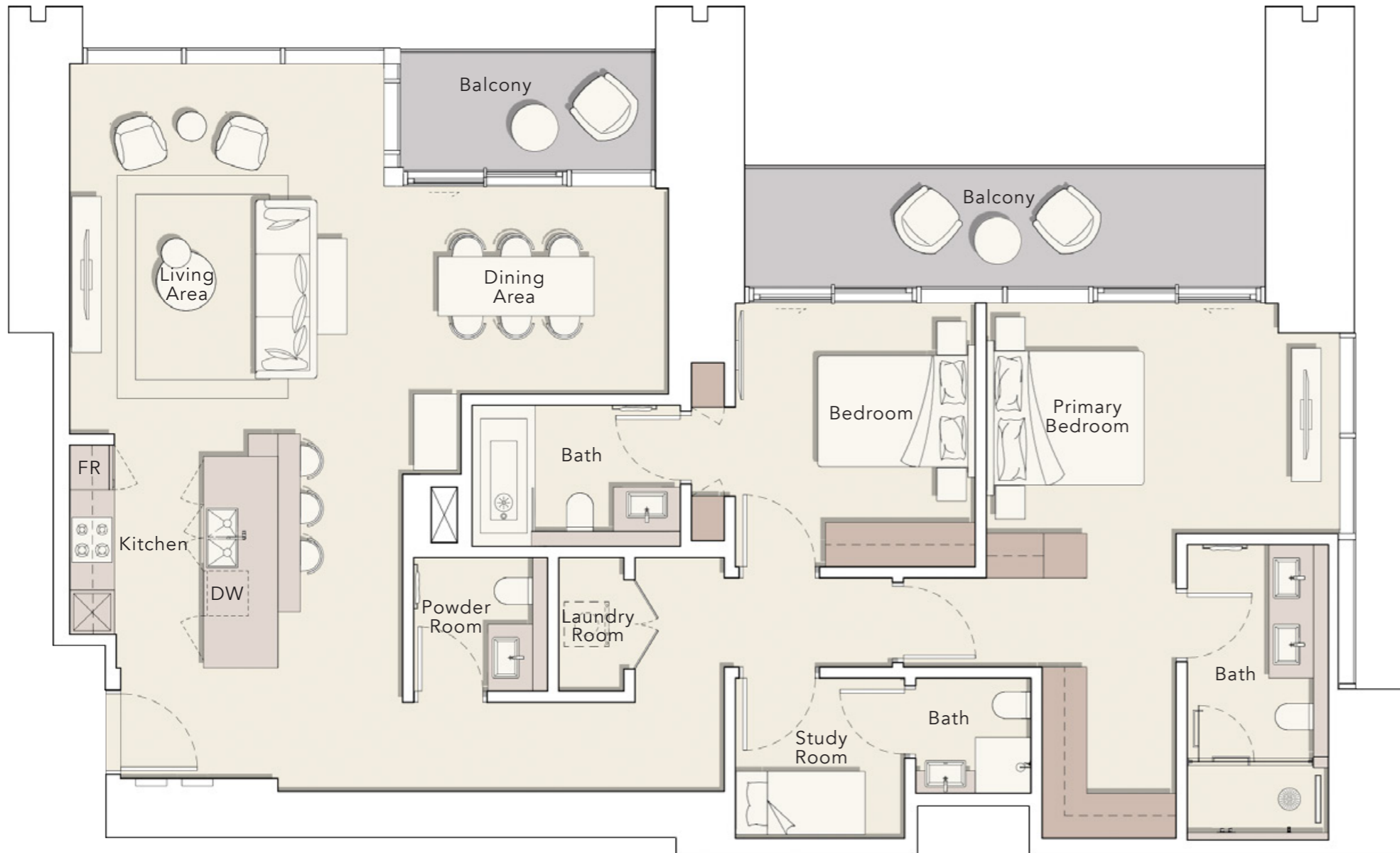

### 3<sup>rd</sup> FLOOR

302

### 4<sup>th</sup> FLOOR

402

### 5<sup>th</sup> FLOOR

502

### 6<sup>th</sup> FLOOR

602

### 7<sup>th</sup> FLOOR

702

### 8<sup>th</sup> - 16<sup>th</sup> FLOOR

804

### 18<sup>th</sup> - 36<sup>th</sup> FLOOR

1804

### 8<sup>th</sup> - 16<sup>th</sup> FLOOR

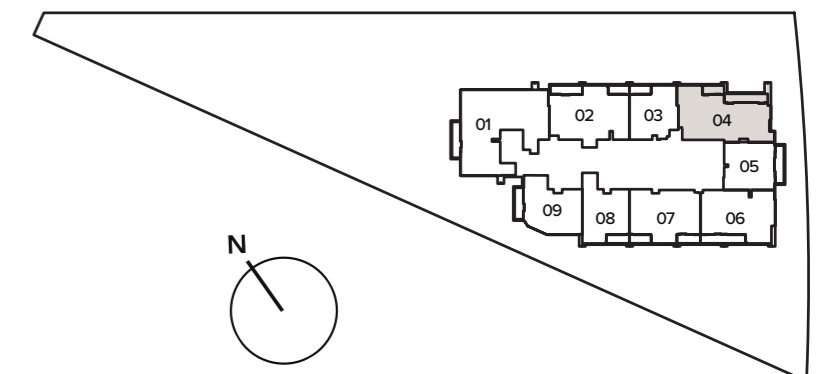

# 2 BEDROOM + S

TYPE B

Internal Living Area : 1509.53 Sq. Ft

Outdoor Living Area : 178.79 Sq. Ft

Total Living Area : 1688.32 Sq. Ft



**8<sup>th</sup> - 16<sup>th</sup> FLOOR**

802

**18<sup>th</sup> - 36<sup>th</sup> FLOOR**

1802

**8<sup>th</sup> - 16<sup>th</sup> FLOOR**

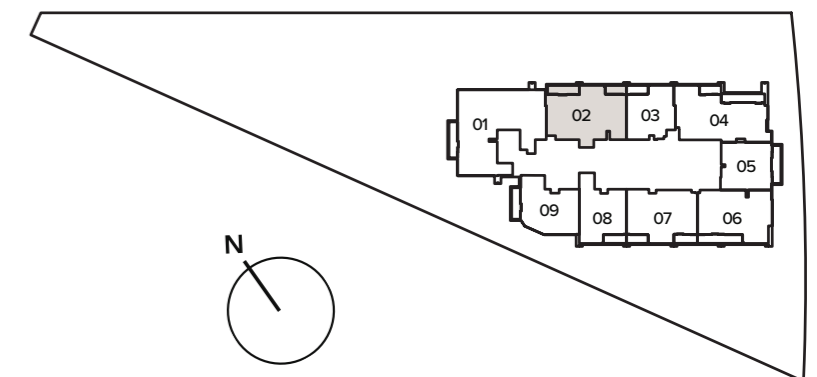

# 2 BEDROOM + S

TYPE C

Internal Living Area : 1678.20 Sq. Ft

Outdoor Living Area : 107.10 Sq. Ft

Total Living Area : 1785.30 Sq. Ft



18<sup>th</sup> - 36<sup>th</sup> FLOOR

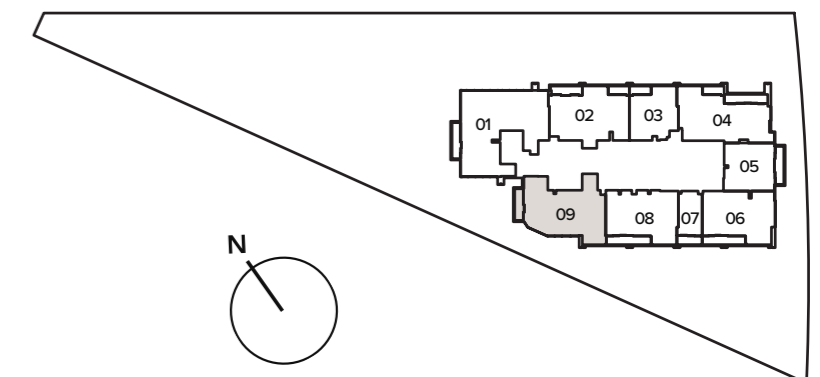

# 3 BEDROOM

TYPE A

Internal Living Area : 2276.24 Sq. Ft

Outdoor Living Area : 121.09 Sq. Ft

Total Living Area : 2397.34 Sq. Ft



8<sup>th</sup> - 16<sup>th</sup> FLOOR

801

18<sup>th</sup> - 36<sup>th</sup> FLOOR

1801

8<sup>th</sup> - 16<sup>th</sup> FLOOR

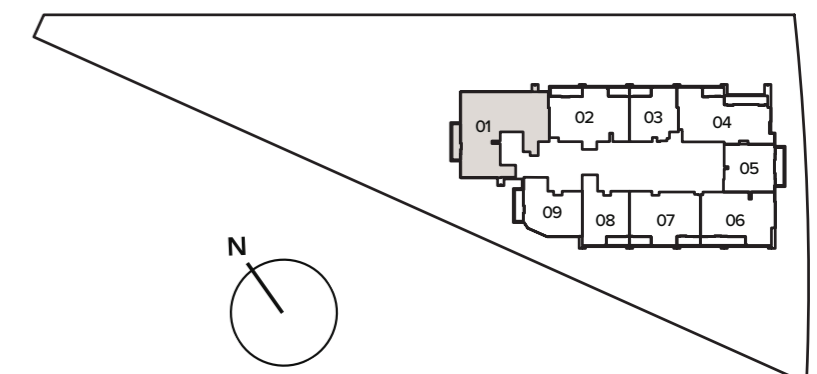

# 3 BEDROOM DUPLEX

TYPE A

Internal Living Area : 3007.22 Sq. Ft

Outdoor Living Area : 707.30 Sq. Ft

Total Living Area : 3714.52 Sq. Ft

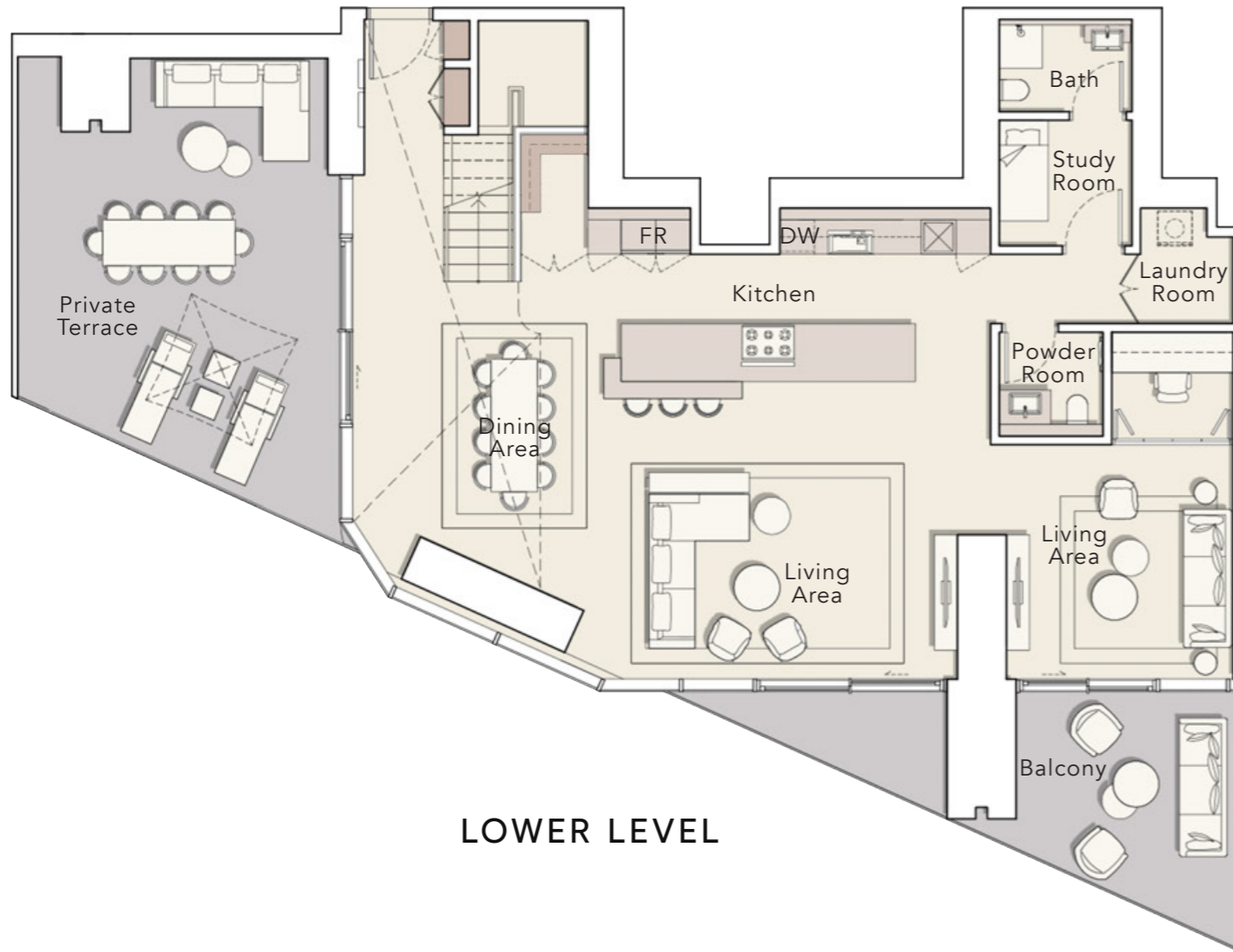

LOWER LEVEL

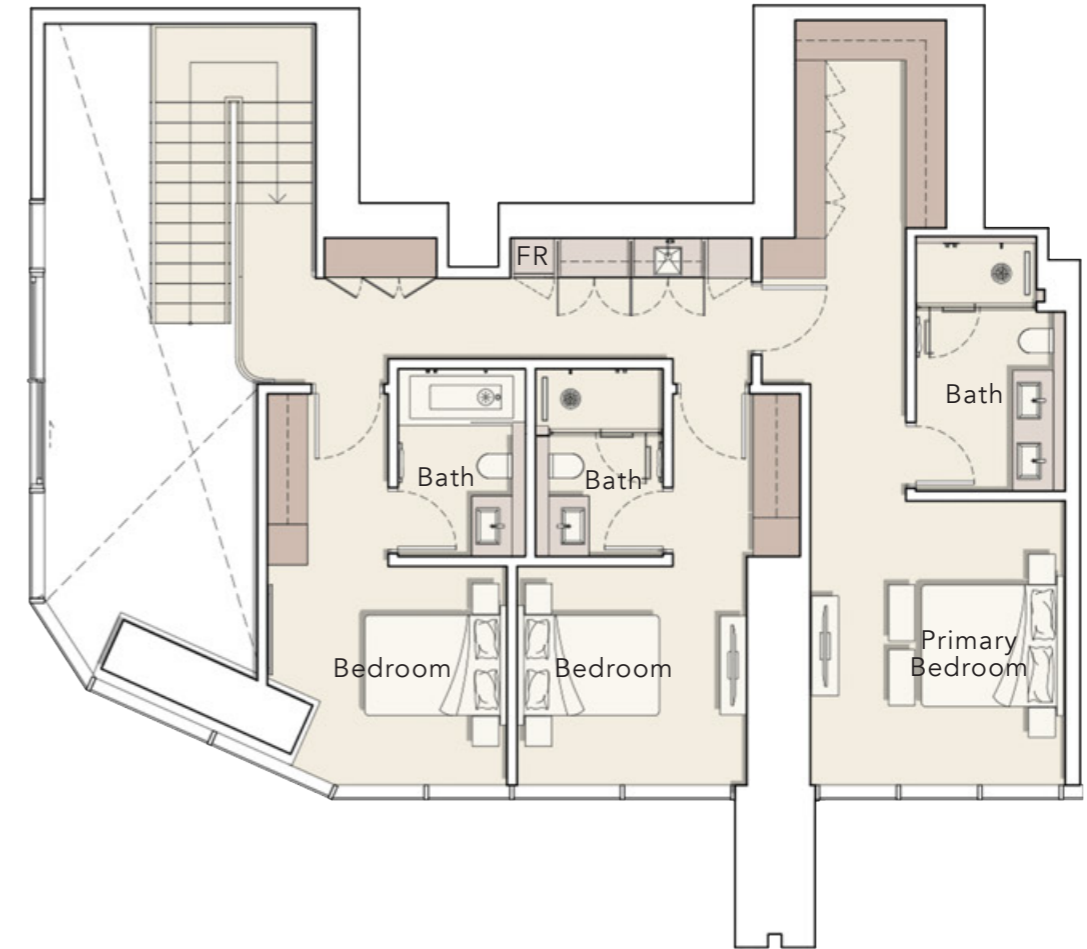

UPPER LEVEL

1st FLOOR

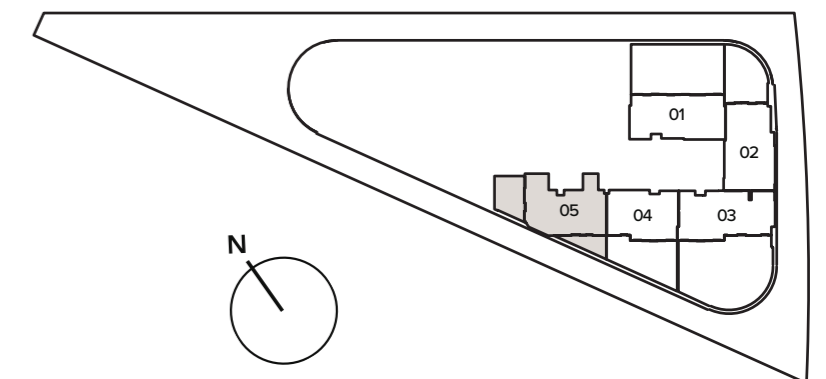

# 3 BEDROOM DUPLEX

TYPE B

Internal Living Area : 2468.49 Sq. Ft

Outdoor Living Area : 993.62 Sq. Ft

Total Living Area : 3462.10 Sq. Ft

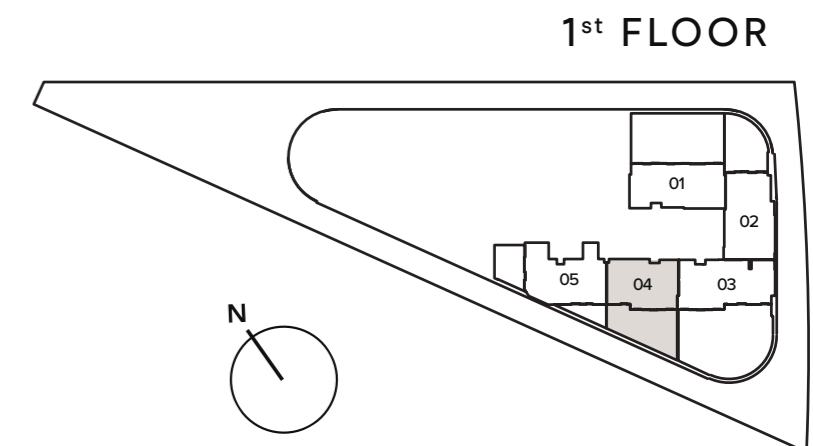
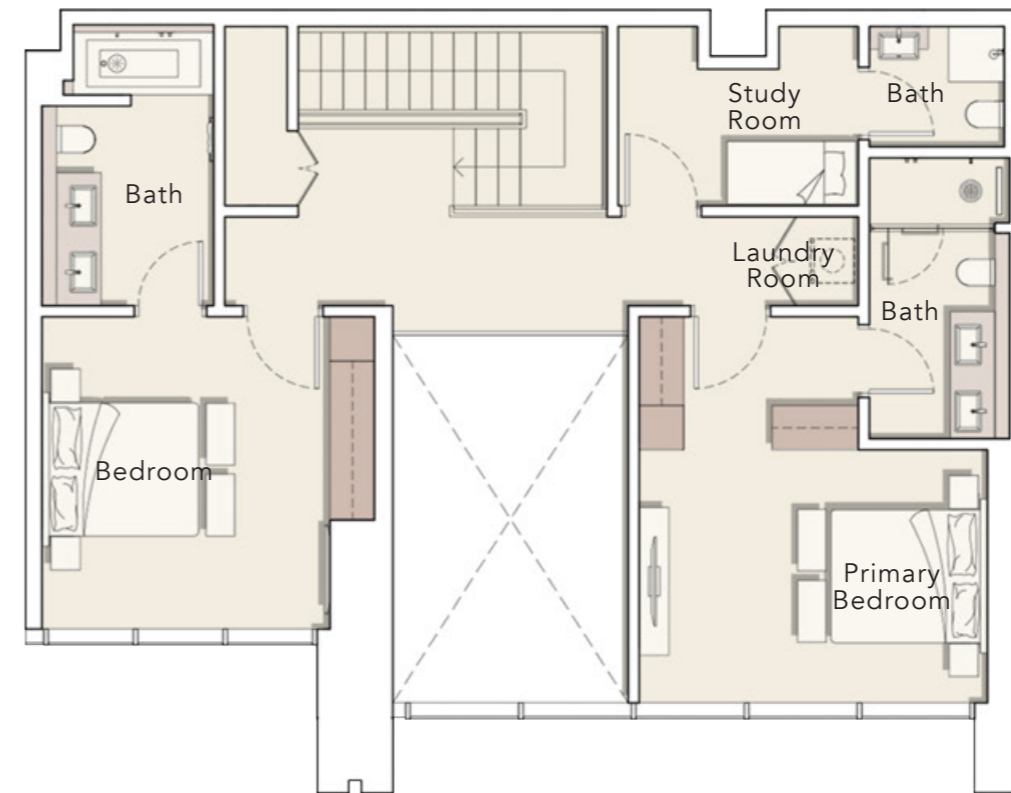
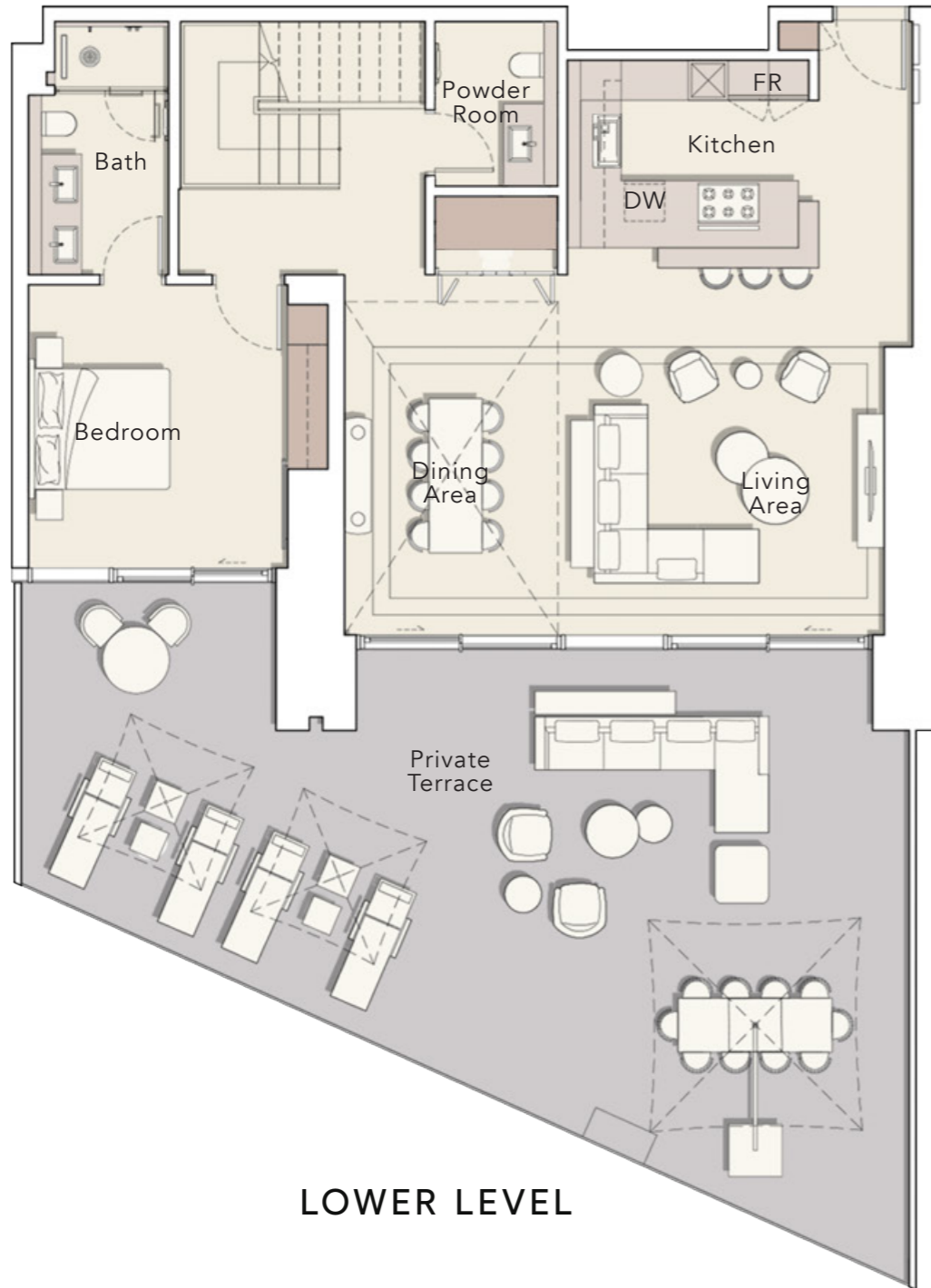

# 3 BEDROOM DUPLEX

TYPE C

Internal Living Area : 3125.73 Sq. Ft

Outdoor Living Area : 842.92 Sq. Ft

Total Living Area : 3968.65 Sq. Ft

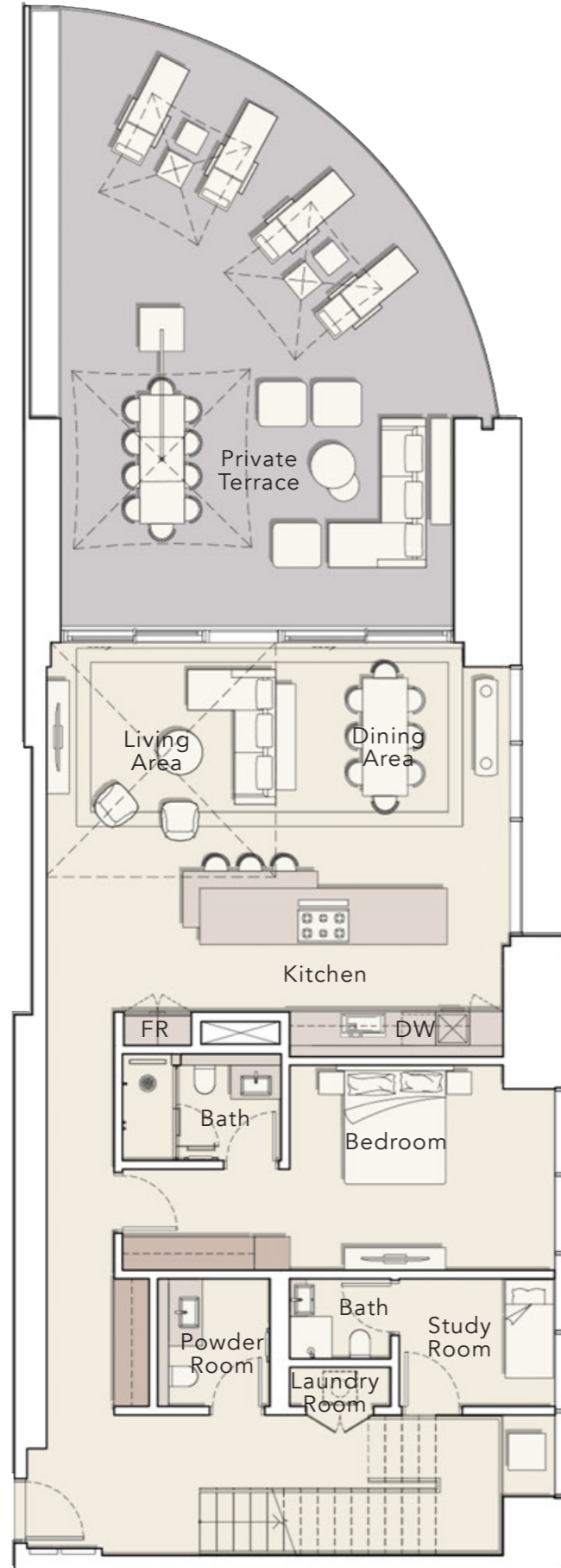

LOWER LEVEL

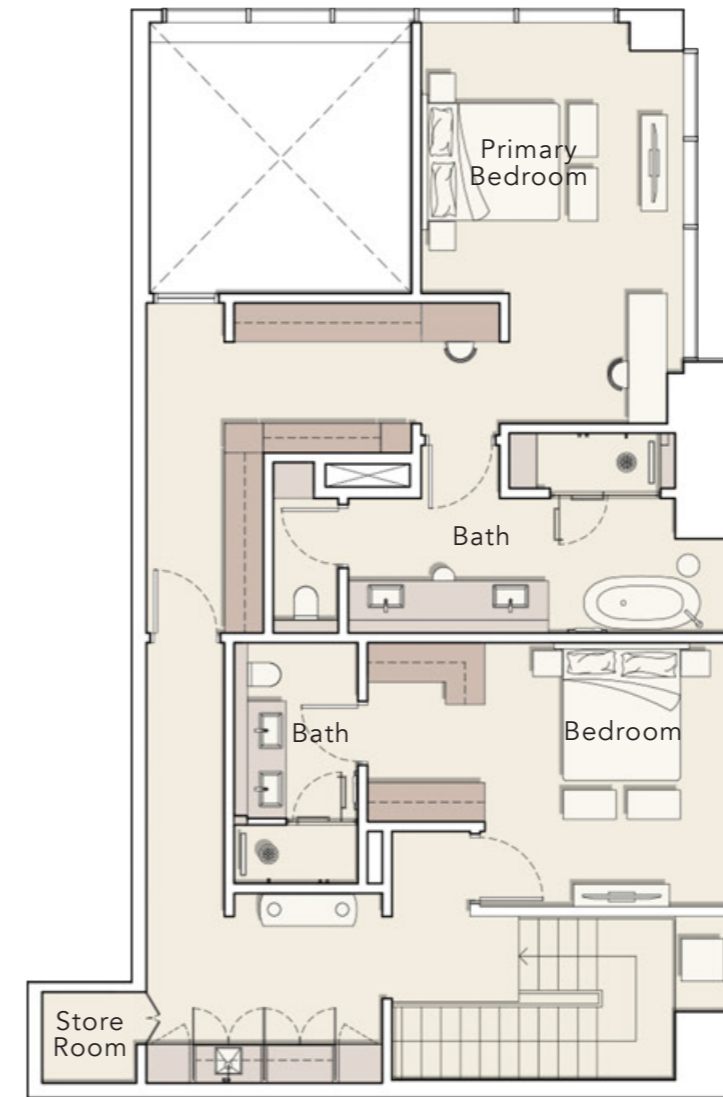

UPPER LEVEL

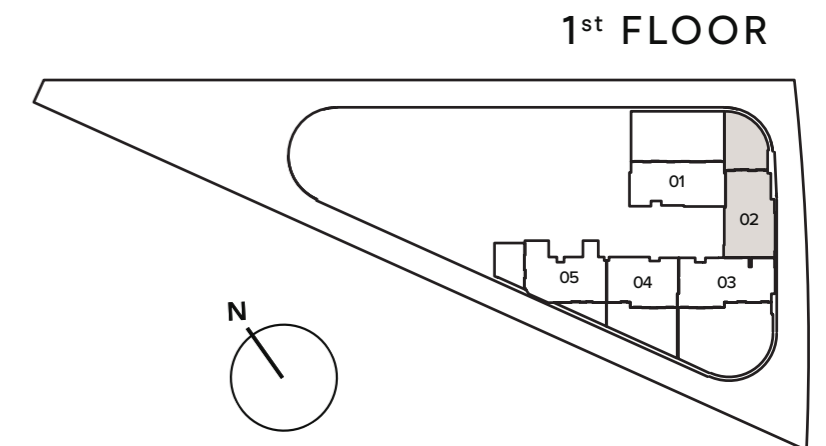

1st FLOOR

# 4 BEDROOM DUPLEX

TYPE A

Internal Living Area : 3128.96 Sq. Ft

Outdoor Living Area : 1842.89 Sq. Ft

Total Living Area : 4971.85 Sq. Ft

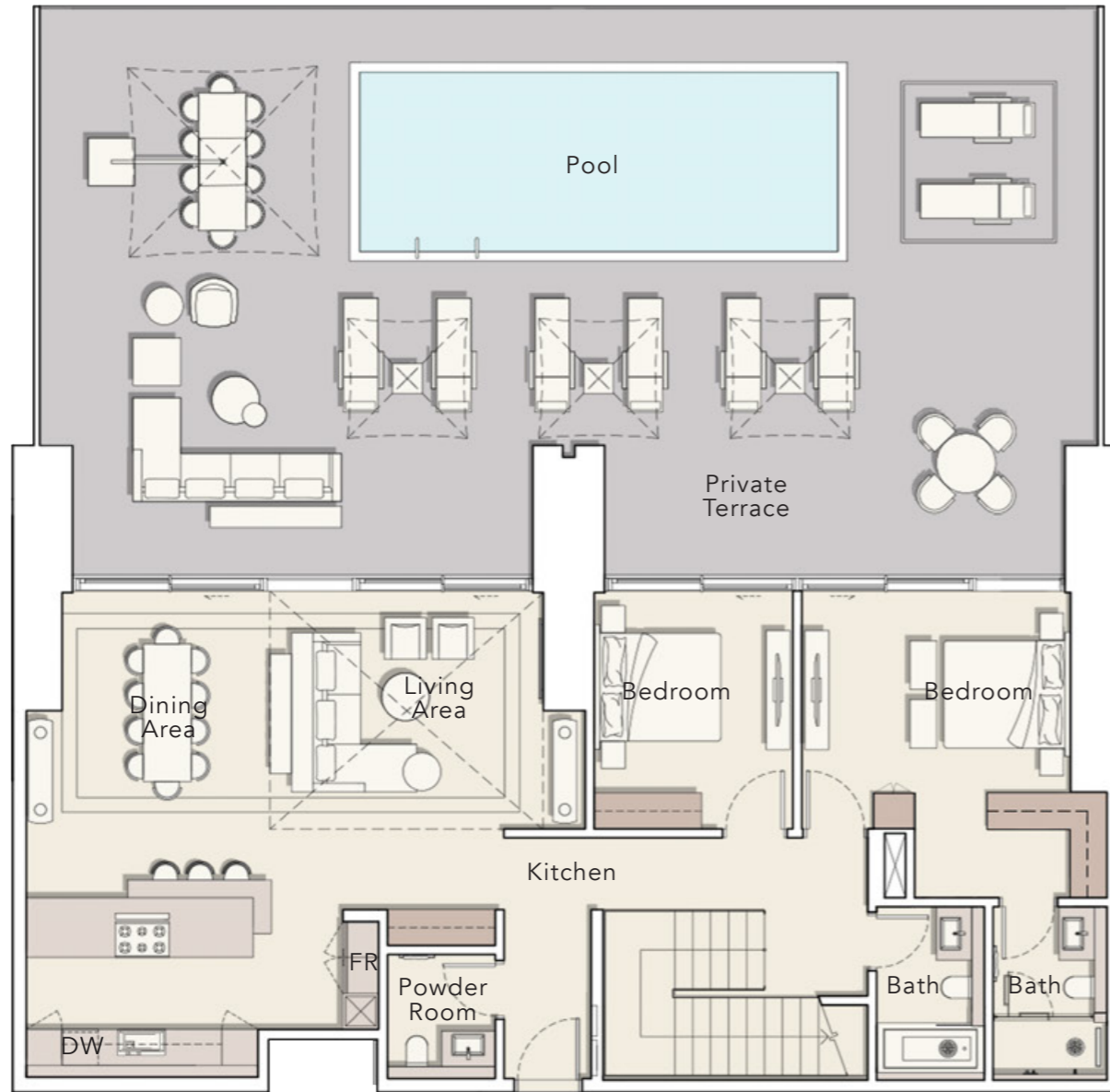

LOWER LEVEL



UPPER LEVEL

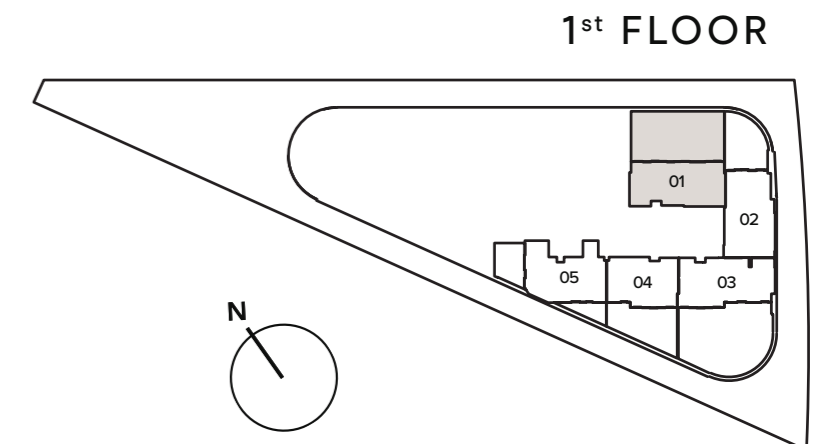

1st FLOOR

# 4 BEDROOM DUPLEX

TYPE B

Internal Living Area : 3246.50 Sq. Ft

Outdoor Living Area : 2329.74 Sq. Ft

Total Living Area : 5576.24 Sq. Ft

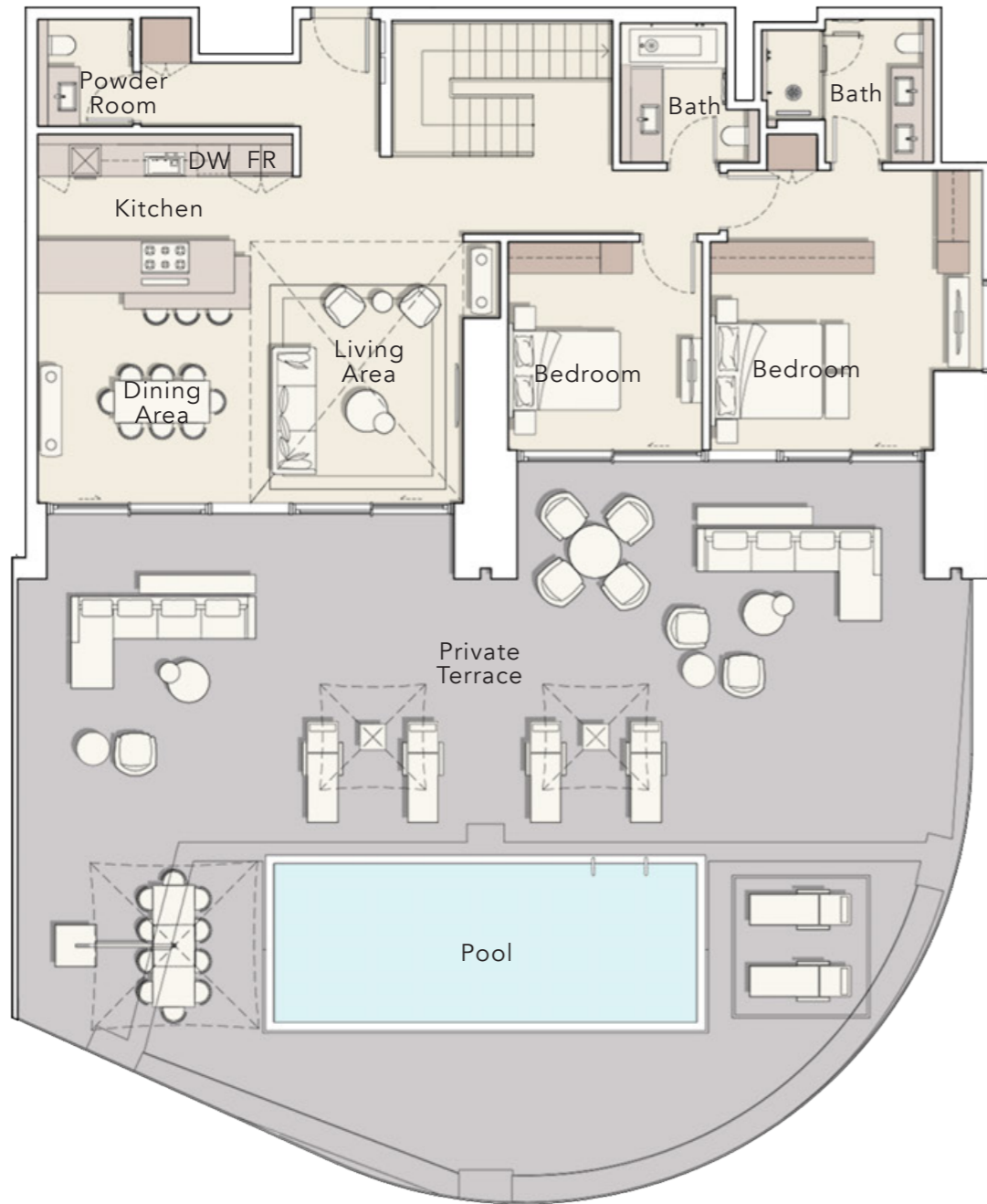

LOWER LEVEL

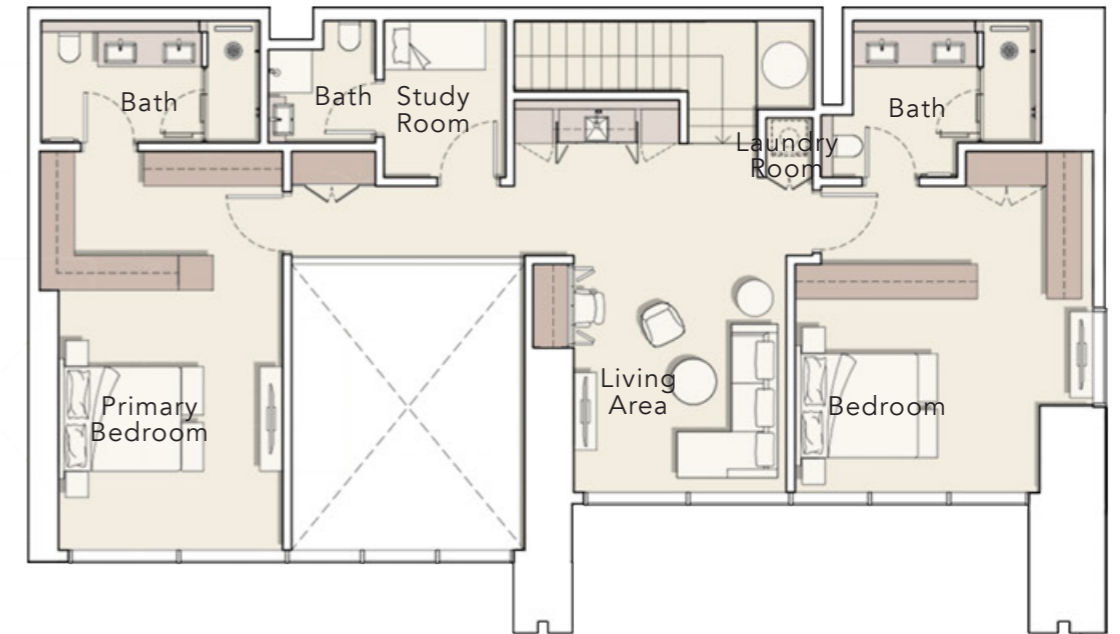

UPPER LEVEL

1st FLOOR

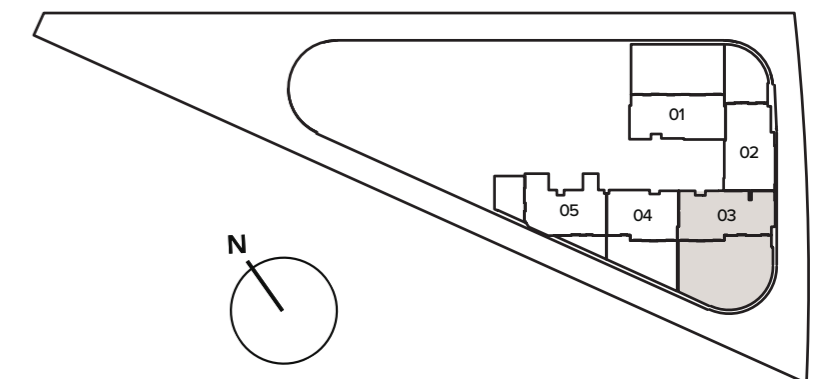

# PENTHOUSE

TYPE A

Internal Living Area : 3398.92 Sq. Ft

Outdoor Living Area : 2448.57 Sq. Ft

Total Living Area : 5847.49 Sq. Ft

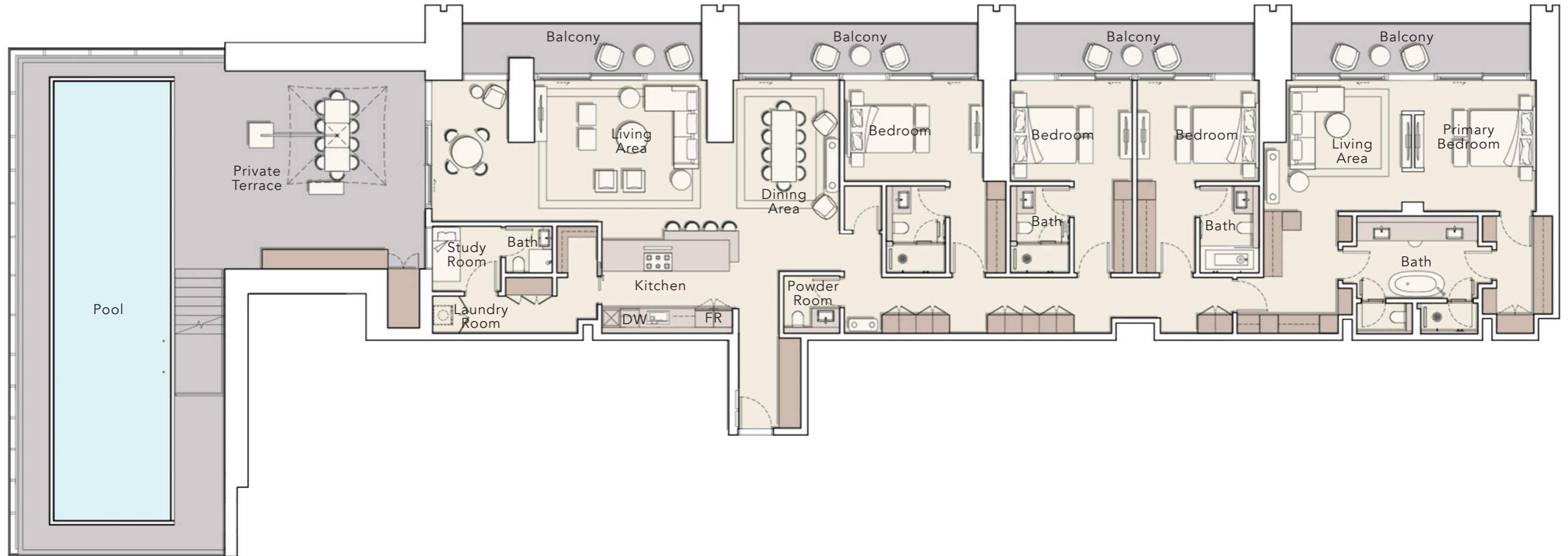

37<sup>th</sup> FLOOR

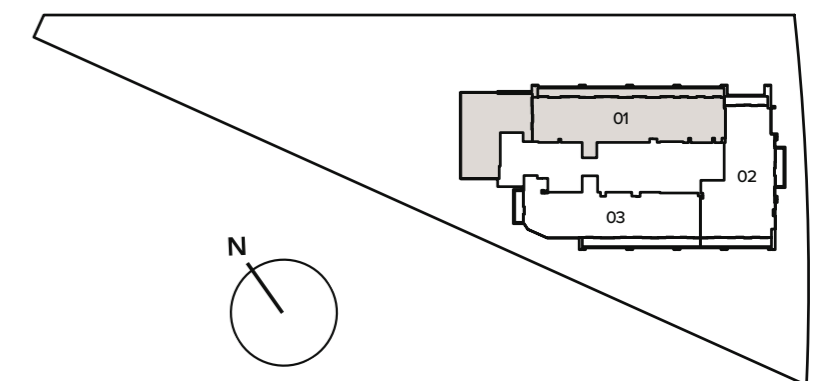

# PENTHOUSE

TYPE B

Internal Living Area : 3221.42 Sq. Ft

Outdoor Living Area : 513.22 Sq. Ft

Total Living Area : 3734.65 Sq. Ft

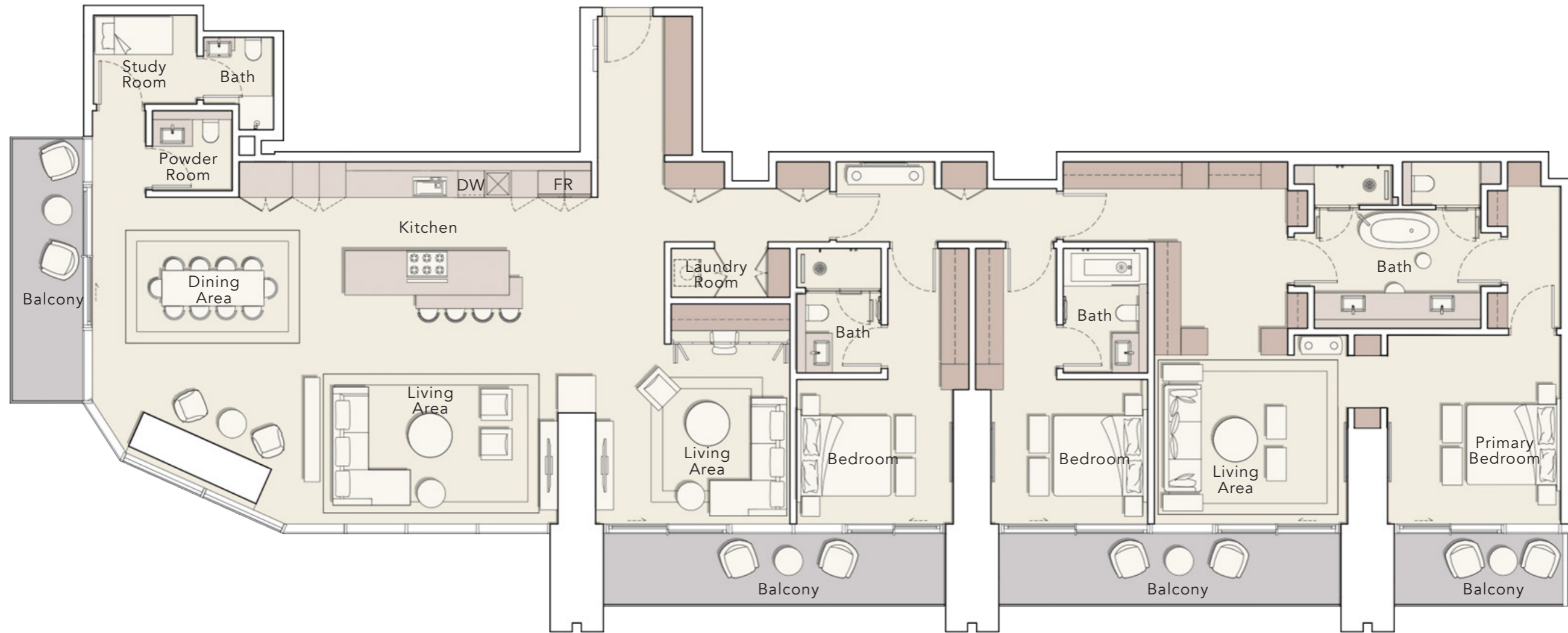

37<sup>th</sup> FLOOR

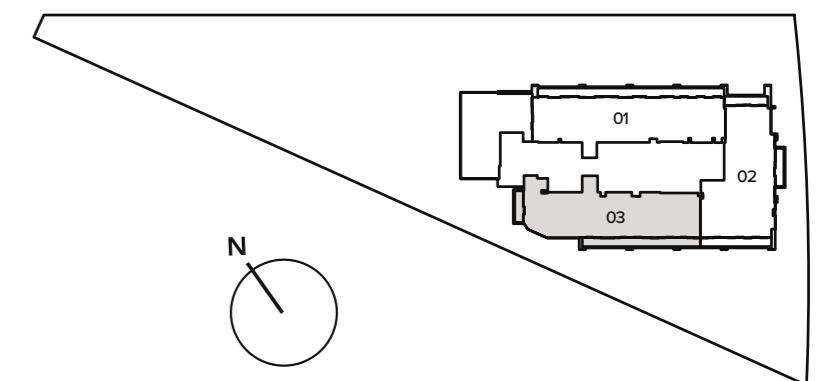

# PENTHOUSE

TYPE C

Internal Living Area : 2980.96 Sq. Ft

Outdoor Living Area : 521.83 Sq. Ft

Total Living Area : 3502.79 Sq. Ft

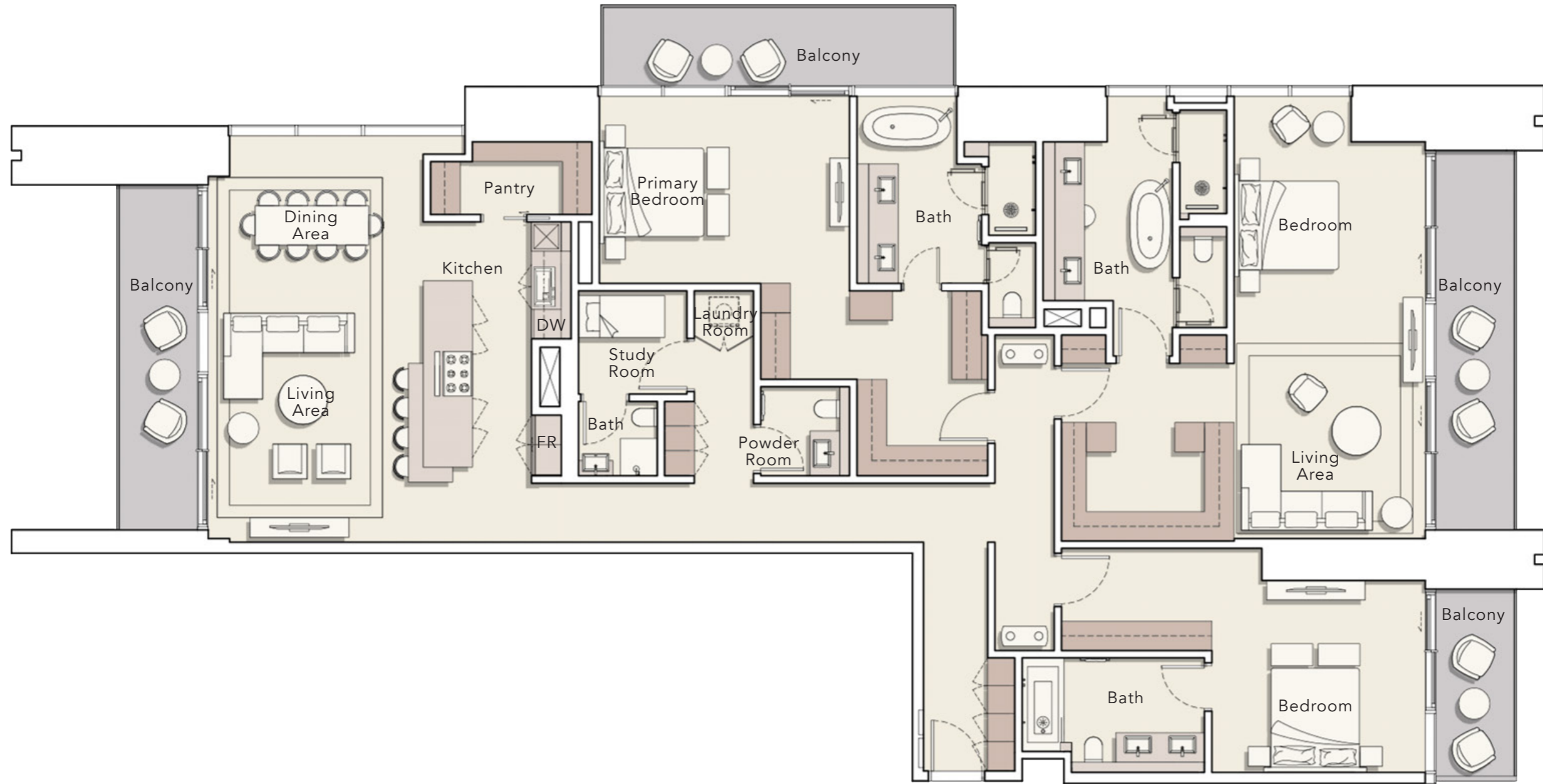

37<sup>th</sup> FLOOR

